

A person is standing on a rocky mountain trail, looking out over a vast mountain range. The sky is blue with some white clouds. The mountains are rugged and have some snow or ice on their peaks. The overall scene is a high-altitude mountain landscape.

2024-2025 PRODUCT GUIDE





CONTENTS

4  Tents

11  Sleeping bags

28  Mats & Pillows

32  Furniture

35  Packs

40  Marine Gear

44  Cookware & Tableware

51  Bottle & Flasks

52  Personal Hygiene & Care

54  Emergency & First Aid

56  Hiking & Snowshoeing

60  Atsko Sno-Seal

61  CTO Footwear



TENTS

Chinook Tents are all about the details...



Polyester flysheets with minimum 2000mm PU waterproof coating and extra UV-resistant treatment on fabric for added protection against damaging UV rays.



Bathtub style floors have minimum 2000mm polyurethane coating for super waterproof protection.



Heavy-duty fiberglass poles for reliability and strength, or **lightweight 7000 series aluminum poles** for superior strength and structural integrity under extreme conditions.



Extremely durable nylon coil zippers on all doors and on all windows.



Waterproof construction with polyurethane hot-taped seams on all main floors and fly seams.



Double-stitched and nylon tape-reinforced seams on all strain-bearing upper canopy seams.



Extra large "D" doors with one-zip opening for quick and easy access.



Large door windows with "no-see-um" mesh for added ventilation, visibility and protection from insects.



Web loop and grommet/clip and sleeve systems for reliability, strength and easy pitching.



Heavy-duty guy points made of delta-shaped fiber-glass reinforced polyethylene for superior strength under extreme conditions.



Large gear loft is included with each Chinook tent for added storage space.



Tent accessory package -- All Chinook tents include tent pegs, guy lines and storage sacks for tent, pegs, and poles.

Ultraviolet Light Warning
All tents & tarps Chinook carries are designed for occasional use and not for permanent or continuous season-long use. Prolonged exposure may result in damage from ultraviolet light. UV damage is not covered by our manufacturer warranty.



Twin Peaks Guide 4+ Person 3-Season Tents

(Double Wall)

Twin Peaks Guide 4 Product # 11422 (FG Poles)

Featuring another innovative design concept in family/group tents: Chinook's InterDome™, a 2 tent-in-1 system, for double the living space. One very roomy sleeping dome, plus a functional and practical screened dome with a removable heavy-duty floor will make you the envy of the campground.

- » Extremely large screened dome is big enough to fit a picnic table.
- » Both InterDome™ rooms have plenty of headroom with peaks that are 6'6" high.
- » Heavy duty, oxford nylon floor on main dome will stand up to repeated camp cot and foot traffic. Very durable PE floor on the screened dome can be removed if necessary.
- » Two large doors on the fly double as sun and rain awnings.
- » Extra long tent fly has delta panels to help keep rain well away from the tent floor and body.
- » Designed for a quick and easy set-up so you can enjoy the great outdoors faster.

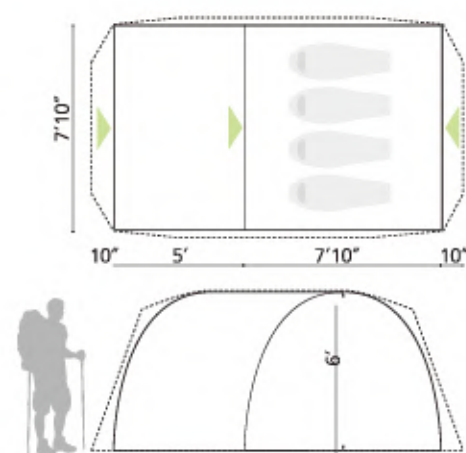

Twin Peaks Guide 4	
Weight	Fiberglass: 24 lb (10.9 kg)
Poles	4 + ridge
Doors	2 doors
Height	6' (183 cm)
Floor	12'10" x 7'10" (391 x 239 cm)
Body area	101 ft ² (9.3 m ²) w/ vestibule: 112 ft ² (10.4 m ²)
Box Size	22" x 10.5" x 10.25" (56 x 27 x 26 cm)



Bivy Sacks

Summit Bivy

HYPERH₂O™



*Sleeping bag not included



Product # 01902BU (Blue) 01902OL (Olive)

The Summit Bivy is an advanced bivy sack system that uses aluminum poles to create a self-supporting canopy around the facial area. This allows better breathability and movement without added exposure to the elements. A great choice for multi-day wilderness trips, snow-camping and emergency situations.

- » Waterproof/breathable nylon top fabric with 2000mm PU coating and waterproof nylon bottom fabric with 5000mm PU coating.
- » Factory-taped seams are completely waterproof.
- » Facial ventilation system for better breathability.
- » Contoured hood and comfortable roomy footbox.
- » Includes a stuff sack.

Size	91" x 32" x 22" / H 17" (230 x 80 x 55 cm / H 42 cm)
Weight	2 lb (0.92 kg)



HYPERH₂O™

Developed exclusively for use in Chinook® products, Hyper H₂O™ is a proprietary waterproof/breathable fabric that is laminate-bonded for excellent moisture-management and durability.





Tent Accessories NEW

Chinook Tarps :: Lightweight :: Waterproof :: Premium quality

These all-condition, all-purpose tarps are perfect anytime you need protection from sun or rain. Compact packing size and lightweight fabric make these the ideal tarps for any backpacking, group camping or water sports trip. Numerous guy points and special catenary cuts ensure a taut pitch.

Guide Silver Coated HD Tarp



Heavy Duty Tarp



	9'10" x 6'7"	12'10" x 9'10"	9'6" x 9'6"	14' x 12'
Product #	11030	11032	11034	11036
Weight	1.3 lb (590 g)	2.1 lb (983 g)	1.7 lb (768 g)	3.1 lb (1400 g)
Features	<ul style="list-style-type: none"> » Ripstop Polyester 75D-210T with 2000mm Polyurethane waterproof coating » UV Resistant treatment to help protect the fabric against damaging UV rays » Fully seam taped construction » Light weight and highly versatile » Perfect for day or overnight use » Silver coating reduces heat from the sun » Inner loop for hanging lantern or clothes line 			

	9'6" x 9'6"	12' x 9'6"	12' x 14'
Product #	11040 (Dark Green) 11041 (Sand)	11045 (Dark Green) 11046 (Sand)	11050 (Dark Green) 11051 (Sand)
Weight	1.6 lb (750 g)	2.1 lb (945 g)	3 lb (1355 g)
Features	<ul style="list-style-type: none"> » Ripstop Polyester 75D-210T with 2000mm Polyurethane waterproof coating » UV Resistant treatment to help protect the fabric against damaging UV rays » Fully seam taped construction » Very durable guy loops and Center tie points » Made of Nylon webbing with extra reinforcement along corners » Inner loop for hanging lantern or clothes line 		

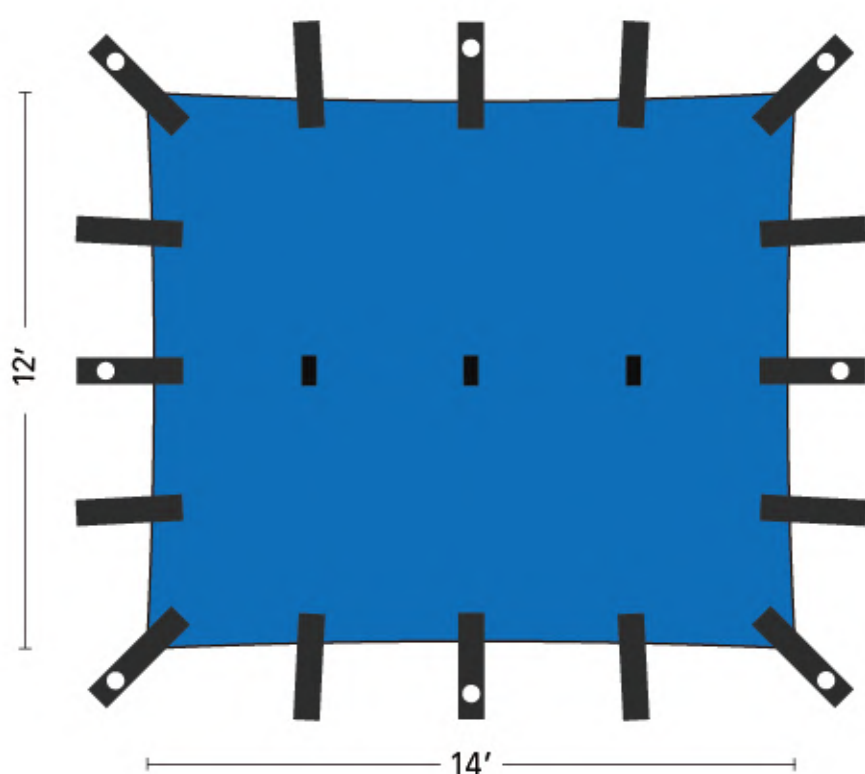
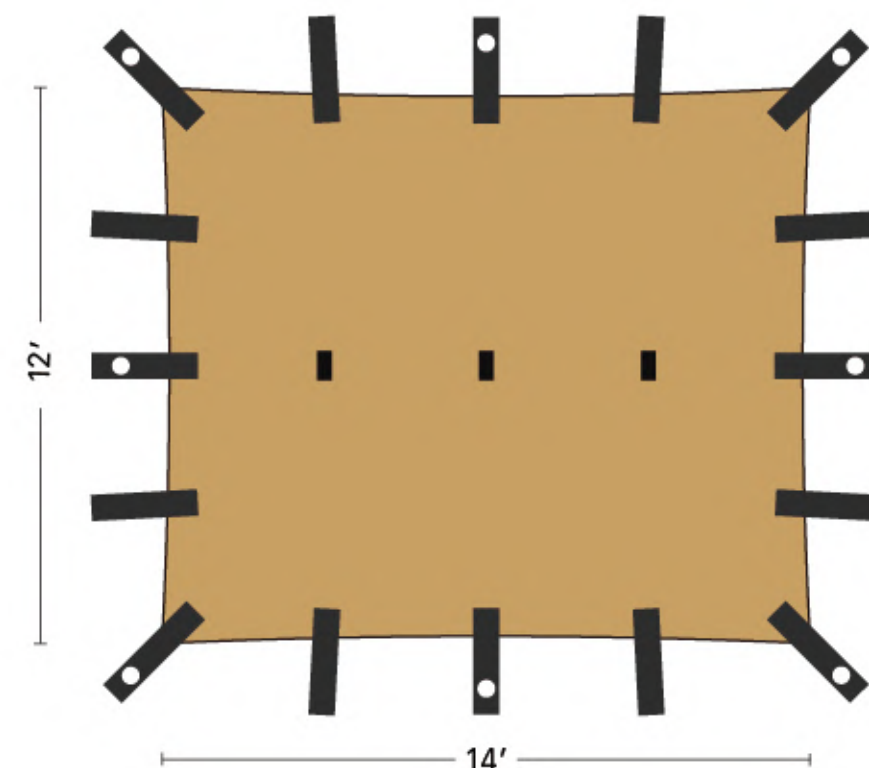
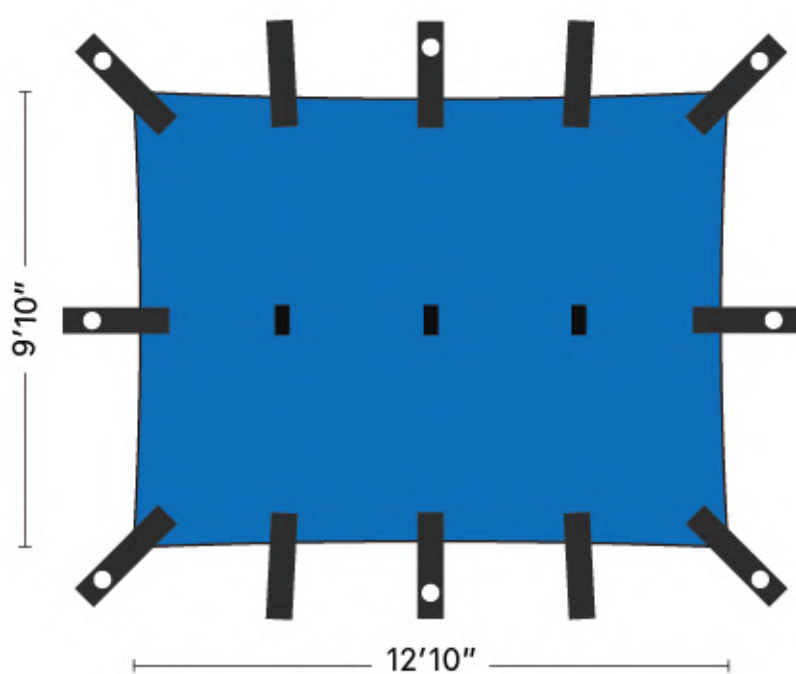
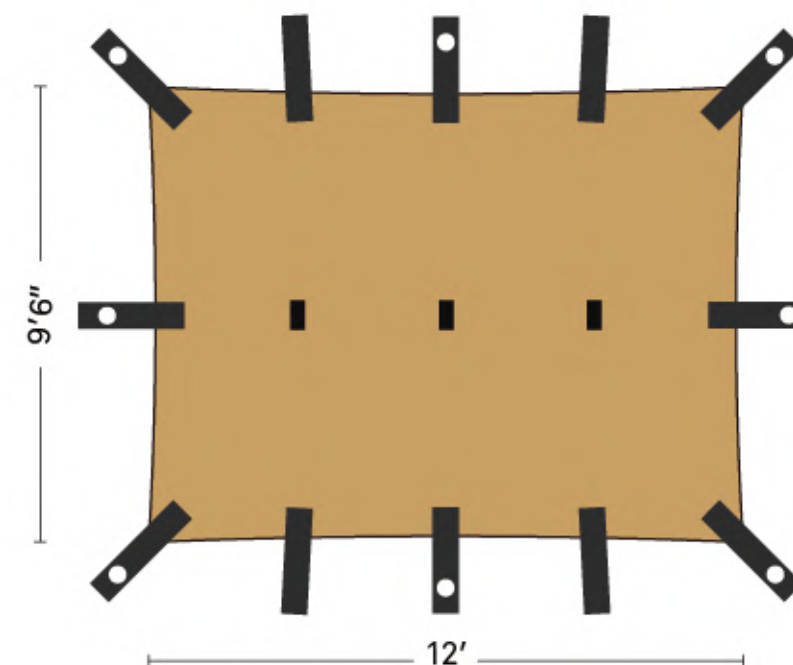
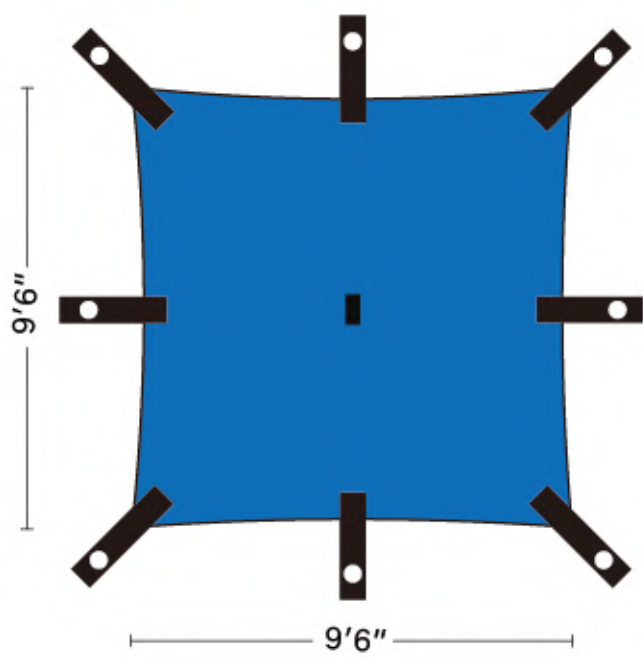
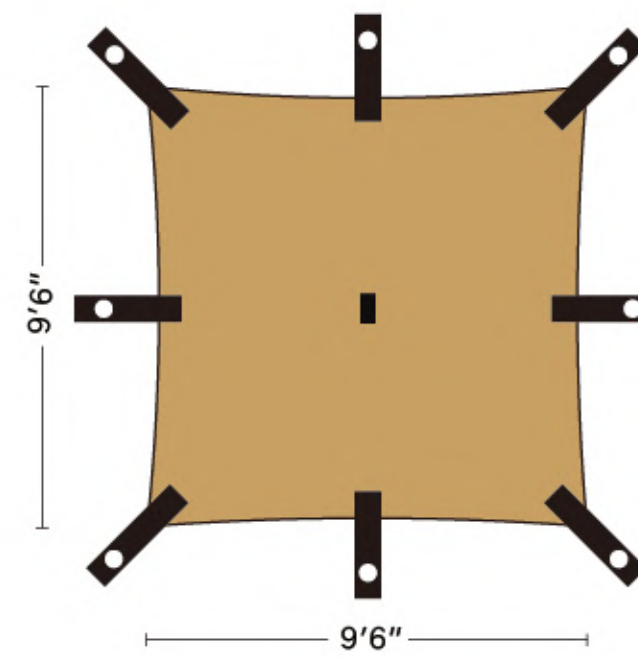
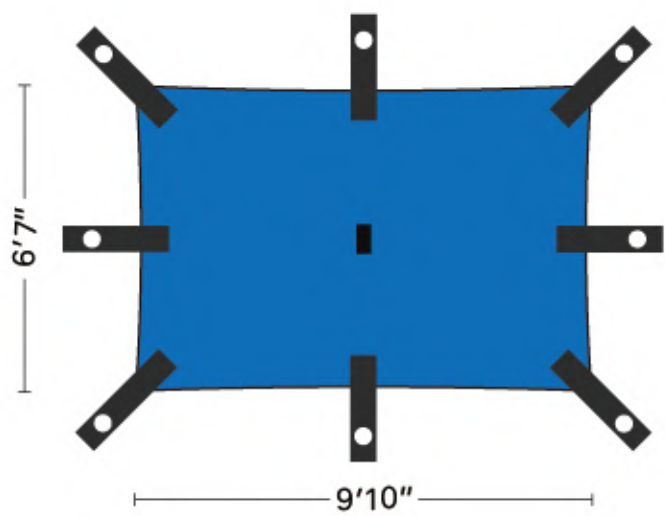



Aluminum Tarp Pole **NEW**

Product # 12016

- » Extends to 94" height (240 cm)
- » Adjustable down to 83" (211 cm) long
- » 19-22 diameter
- » 6061 Aircraft Aluminum
- » Carry bag included
- » Shock corded

Weight: 1.22 lb (556 g)



Tarp Pole Twist Lock **NEW**

Product # 12017

- » Adjustable up to 102" (260 cm) height
- » Adjustable down to 40" (102 cm) long
- » 6061 Aircraft Aluminum
- » 3 section adjustable twist lock
- » Built-in guyline loop attachments

Weight: 1 lb (490 g)



Kenyon Tent Repair Products

Seam Sealer 3 Water-based Formula



Product # 62020

Seam Sealer 3 water-based formula is the standard in aqueous urethane waterproof coating for seams. This seam sealer has handy applicator tip for ease of application.

Size: 2 fl oz (60 mL)

Klear K-Tape Repair Tape



Product # 62005

No need to match colors with this transparent, highly durable, UV stable, abrasion-resistant urethane tape. This tape is truly universal and can be used on all smooth synthetic fabrics, fleece fabric, plus vinyl.

Size: 3" x 18" (7.5 x 45 cm)

K-Tape Repair Tape



Product # Ripstop Nylon: 62001 (Assorted) 62002 (Black)
Taffeta Nylon: 62003 (Assorted) 62004 (Black)

K-Tape Repair Tapes will repair all smooth nylon fabrics and is easy to apply with pressure sensitive self-sticking tape. This repair tape is durable, will withstand weather condition and repeated washing. Comes in black and assorted colors.

Size: 3" x 18" (7.5 x 45 cm)



Tent Pegs



Aluminum Tent Pegs Product # 18107 (7")

Lightweight tent pegs made of strong aluminum.
Bulk (25 pieces)



Heavy Duty Steel Tent Pegs Product # 18110 (10")

Large nail style tent pegs made of heavy-duty steel with a plastic stop shield at the top.
Bulk (25 pieces)



Hex Aluminum Pegs **NEW** Product # 18401

6061 Aluminum
Length 7 inch (180 mm)
Weight 0.5 oz (15 g)
Bulk (4 pieces)



Triangle Aluminum Pegs **NEW** Product # 18402

6061 Aluminum
Length 9 inch (230 mm)
Weight 0.5 oz (15 g)
Bulk (4 pieces)



Triangle Aluminum Pegs **NEW** Product # 18403

6061 Aluminum
Length 9 inch (230 mm)
Weight 0.58 oz (16 g)
Bulk (4 pieces)

Tent Accessory Kit



Product # 18170

Contains rubber mallet, brush, dustpan, 2 guyline ropes and tighteners, peg puller, 8 steel pegs, and mesh bag.

Pole & Tent Repair Accessories



Ferrules for pole ends
Product # 12012
0.308" (7.9 mm) diameter
Bulk (25 pieces)



Tips for pole ends
Product # 12014
0.308" (7.9 mm) diameter
Bulk (25 pieces)



Aluminum Guyline Slide Adjuster
Product # 18150
Fits all regular guyline cords.
Bulk (50 pieces)

26" Pole Section Product # 12010

0.308" (7.9 mm) diameter



Utility Cord

Product # 18165 (100' / 30 m)
Heavy duty nylon braided PE cord with 500 lb of tensile strength.



Guyline Kit Product # 18152

Contains 8 guyline tighteners and 20' of heavy-duty cord that can be cut to size.

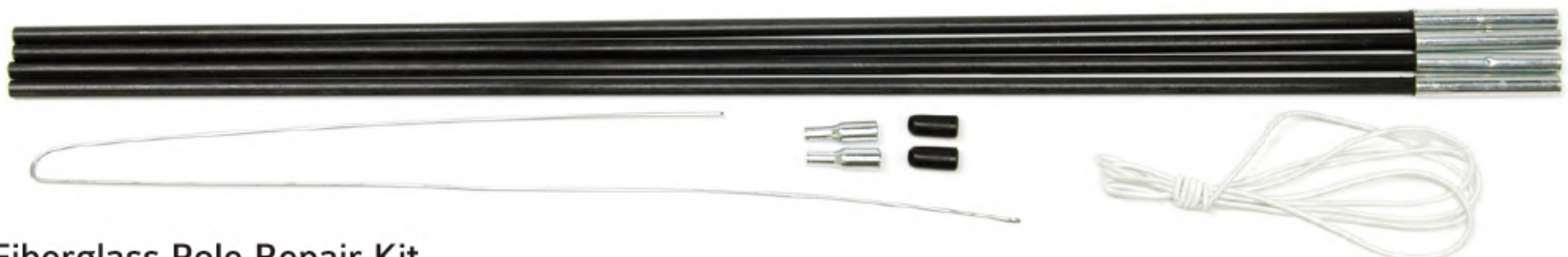

Fiberglass Pole Repair Kit

Product # 12001 (0.308" / 7.9 mm dia.) Handy repair kit comes with 4 fiberglass pole sections, each is 26.5" and tipped with a ferrule, 2 grommet end tips, 2 vinyl end caps, 2 feet of shock-cord and 1 cord threader.
12002 (0.333" / 8.5 mm dia.)
12003 (0.372" / 9.5 mm dia.)
12004 (0.437" / 11 mm dia.)

Tarp Accessories



Aluminum Rope Tensioner **NEW** Product # 18406

6061 Aluminum
Size 0.63 x 1.54 in (15 x 40 mm)
Hole diameter 0.25 in (6 mm)
Ultralight + durable 2 hole design
Used for tents, tarps and all outdoor activities
Bulk (6 pieces)



Guy Lines C/W Adjuster **NEW** Product # 18404

13 ft (396 cm) cord, Reflective 4 mm - Paracord Ultralight + durable 2 hole design
Used for tents, tarps and all outdoor activities
Weight 0.58 oz (16 g)
Bulk (4 pieces)

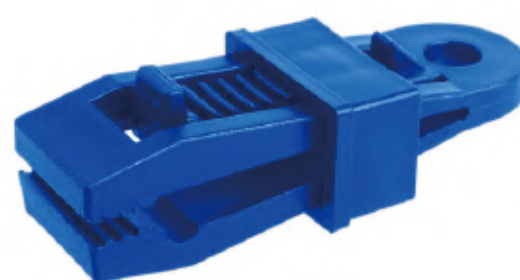

Tarp Grommet Tie Downs **NEW** Product # 18405

Nylon Resin material
Adjustable design, easy on+off
Used for tents, tarps, awnings, car covers, all purpose
Size 3.5 in (9 cm)
Weight 0.76 oz (21.5 g)
Bulk (2 pieces)



SLEEPING BAGS

CANADIAN DESIGN

It's what we're made of...

Down: We source high-quality down that provides excellent heat retention, performance and comfort from quality suppliers. Naturally lightweight and extremely warm insulation.

Invista's Thermolite® insulation has proven  **INVISTA™** its worth in the most demanding environments. Without any kind of chemical treatment, it guarantees warmth coupled with moisture management during physical exertion. Moisture on your skin or clothing not only multiplies your body's heat loss by 25 percent, it also affects your overall performance and endurance in cold conditions.

Insufil®: Engineered by Chinook and industry leading suppliers, we created several high performing insulation:

Insufil® Thermo is made from a mixture of ultra-fine 3denier and 1.5denier fibers, thermally bonded without resin to provide high warmth without bulk. 

Insufil® 4 is made from a mixture of quattro-thermal fiber and spiral fibers for high loft insulation. 

Insufil® 1 is made from a mixture of hollow-cored fiber and spiral fibers resulting in inexpensive luxury insulation. 

Ripstop Nylon: This nylon utilizes a special grid construction to improve toughness and to resist tearing.

Nylon Taffeta: A 100% nylon fabric commonly used for outer shell. This fabric is specially treated for waterproofing and water-repelling.

Polyester: A synthetic woven material known for being durable+ relatively lightweight. Quick drying, moisture repellant, low stretch.

Flannel: Made from 100% brushed cotton, this familiar plaid fabric is known for its warmth and absorbency.

Cotton: A 100% cotton fabric, commonly used for inner lining due to its comfortable feel.

Polycotton: A 65% polyester / 35% cotton fabric. It is lighter than normal cotton fabric, but with almost the same feel.

Polyester Pongee: Chinook engineered this special polyester fabric, which possesses the comfortable touch of cotton while enjoying the light weight quality of nylon.

Chinook[®] sleeping bags carry these great features



-22°F / -30°C

Sleeping bag temperature rating value represents the bag's **temperature limit** and should be used as reference only. Perception of heat varies from person to person and is dependent on various factors such as, physical condition, metabolism, dress, equipment, etc.



1. All Chinook sleeping bags receive **water-repelling treatments** while select bags receive **water-proofing**.

2. **Zipper Guards** keep zippers snag free and have you zipping in and out of your bag with ease.

3. **Draft Tubes** prevent heat loss through the coils of zippers to help you wake-up fully rested.

4. **Velcro Tapes** make sure you sleep tight by securing zip closures, preventing zippers from accidentally coming undone.

5. **Utility Pockets** take care of loose ends by providing a safe and secure place for stashing your valuables, or alarm clock.

6. **Barrel Lock Closures** give you full control over drawcords so you can easily adjust them to your liking.

7. **Thermal Collars** fit snugly around your neck and trap warm air from escaping through the collar, all for a warm night no matter the weather outside.

8. All our sleeping bags* come with one of the following sacks: **standard stuff sack, two way compressible stuff sack or four way compressible stuff sack**. *Some of our oversized sleeping bags come in sturdy duffel bags.

9. Selected Chinook sleeping bags feature **left or right-handed zips** to allow **combining of two sleeping bags together** to form a double bag.



Mummy: This shape is designed along the contours of the human body, thereby eliminating extra cold space. This is the most efficient style.

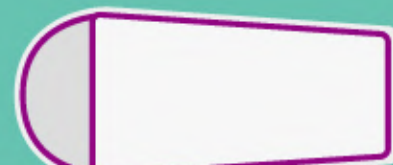

Tapered with Hood: This shape offers more room for movement than the conventional mummy style while retaining the thermal efficient nature.

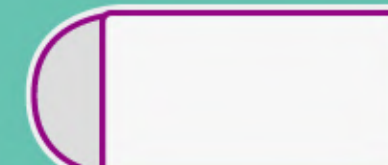

Rectangular with Hood: This shape combines the ease of movement from the rectangular sleeping bag with the comfort of the hood component.



Rectangular: This shape offers sufficient room for movement and the option of using it as a comforter, when it is fully opened.



GOOSE DOWN SERIES

Polar Ice **-22°F / -30°C**



Product # [20701](#)

Size	83" x 32" x 20" (210 x 80 x 50 cm)
Shape	mummy
Construction	horizontal channel design
Outer Shell	ripstop nylon
Lining	nylon
Filling	42 oz (1200 g) of duck down 650+ fill power
Zipper	#5 YKK 2-way, 42" long
Stuff Sack	compression bag
Total Weight	3.5 lb (1.65 kg)

Polar Peak **-5°F / -20°C**



Product # [20710](#)

Size	83" x 32" x 20" (210 x 80 x 50 cm)
Shape	mummy
Construction	horizontal channel design
Outer Shell	ripstop nylon
Lining	nylon
Filling	32 oz (900 g) of duck down 650+ fill power
Zipper	#5 YKK 2-way, 42" long
Stuff Sack	compression bag
Total Weight	3.2 lb (1.35 kg)

Polar Comfort **15°F / -10°C**



Product # [20720](#)

Size	83" x 32" x 20" (210 x 80 x 50 cm)
Shape	mummy
Construction	horizontal channel design
Outer Shell	ripstop nylon
Lining	nylon
Filling	21 oz (600 g) of duck down 650+ fill power
Zipper	#5 YKK 2-way, 42" long
Stuff Sack	compression bag
Total Weight	2.25 lb (1.0 kg)

Polar Micro **32°F / 0°C**



Product # [20732](#)

Size	83" x 32" x 20" (210 x 80 x 50 cm)
Shape	mummy
Construction	horizontal channel design
Outer Shell	ripstop nylon
Lining	nylon
Filling	10.6 oz (300 g) of duck down 650+ fill power
Zipper	#5 YKK 2-way, 42" long
Stuff Sack	compression bag
Total Weight	1.5 lb (0.7 kg)





Fireside Mummy **36°F / 2°C**



Product # 20162 (Blue)

Size	83" x 30" x 20" (211 x 76 x 51 cm)
Shape	mummy
Construction	horizontal channel design
Outer Shell	ripstop nylon
Lining	nylon
Filling	12 oz (350 g) of duck down 575+ fill power
Zipper	#5 YKK 2-way, 42" long
Stuff Sack	compression bag
Total Weight	1.7 lb (0.77 kg)

Fireside Hooded Rectangular **36°F / 2°C**



Product # 20172 (Blue)

Size	(75" + 10") x 32" ((190 + 25) x 81 cm)
Shape	hooded rectangular
Construction	horizontal channel design
Outer Shell	ripstop nylon
Lining	nylon
Filling	16 oz (450 g) of duck down 575+ fill power
Zipper	#5 YKK 2-way, 42" long
Stuff Sack	compression bag
Total Weight	1.9 lb (0.88 kg)



Everest Extreme **-22°F / -30°C** **NEW**

Insufil®
THERMO



Product # 20604

The Everest Extreme is a great winter camping sleeping bag with expedition-ready features such as Insufil Thermo insulation, ergonomic head gasket and foot box, oversized draft tubes and neck collar for added protection in the most extreme conditions. Available with left or right zippers, and may be zipped together with other compatible bags.

Size	(80" + 12") x 34" ((203 + 30) x 86 cm)
Shape	hooded rectangular
Construction	three layers (top) & two layers (bottom)
Outer Shell	nylon
Lining	polyester pongee
Filling	5.4 lb (2480 g) of insufil Thermo
Zipper	#5 YKK 2-way, 65" long
Stuff Sack	cap compression bag
Total Weight	6 lb (2.7 kg)

Everest Supreme **-5°F / -20°C** **NEW**

Insufil®
THERMO



Product # 20614

The Everest Supreme is great for outdoor winter pursuits, when temperatures are not quite so extreme. Expedition-ready features such as Insufil Thermo insulation, ergonomic head gasket and foot box, oversized draft tubes and neck collar. Available with left or right zippers, and may be zipped together with other compatible bags.

Size	(80" + 12") x 34" ((203 + 30) x 86 cm)
Shape	hooded rectangular
Construction	three layers (top) & two layers (bottom)
Outer Shell	nylon
Lining	polyester pongee
Filling	4 lb (1810 g) of insufil Thermo
Zipper	#5 YKK 2-way, 65" long
Stuff Sack	cap compression bag
Total Weight	5 lb (2.3 kg)

Everest Comfort III **15°F / -10°C**

Insufil®
THERMO

More leg room



Product # 20623

The Everest Comfort was specifically designed for outdoor enthusiasts who want more leg room along with the performance of a cold-weather sleeping bag. Chinook uses Insufil Thermo insulation to create this roomy and comfortable sleeping bag. Great for trips in the late autumn or early spring, when the temperature is still below the freezing point.

Size	(80" + 12") x 34" ((203 + 30) x 86 cm)
Shape	hooded rectangular
Construction	two layers
Outer Shell	nylon
Lining	polyester pongee
Filling	2.86 lb (1300 g) of insufil Thermo
Zipper	#5 YKK 2-way, 117" long
Stuff Sack	cap compression bag
Total Weight	4.7 lb (2.13 kg)

Everest Micro II **32°F / 0°C**

Insufil®
THERMO

Light & Compact



Product # 20631

Everest Micro III was designed for ones that like to enjoy more leg room while enjoying the comfort of summer camping, travel or trekking trips. Insufil Thermo is used in this extremely packable and very comfortable bag. Available with left or right zippers, and the bags may be zipped together with other compatible bags.

Size	(80" + 12") x 34" ((203 + 30) x 86 cm)
Shape	hooded rectangular
Construction	one layer
Outer Shell	nylon
Lining	polyester pongee
Filling	14.1 oz (400 g) of Invista Thermolite Hollofil
Zipper	#5 YKK 2-way, 65" long
Stuff Sack	4-way compression bag
Total Weight	2.5 lb (1.15 kg)

Kodiak Extreme III -40°F / -40°C

Insufil®
THERMO



Product # 20451

One of the warmest sleeping bags in the Chinook product line, featuring Insufil® Thermo insulation, ergonomic head gasket and foot box, waterproof/anti-slip HiTex bottom fabric, oversized draft tubes and neck collar for added protection in the most extreme conditions. The Chinook SnugHood design gives the best fit around the facial area providing extra comfort while reducing bulk when the draw cord is fully tightened. Available with left or right zippers, and may be zipped together with other compatible bags.

Size	90" x 34" x 22" (229 x 86 x 56 cm)
Shape	mummy
Construction	four layer shingle design
Outer Shell	nylon
Lining	polyester pongee
Filling	6 lb (2700 g) of Insufil Thermo
Zipper	#8 YKK 2-Way, 65" reversible, auto-lock
Stuff Sack	cap compression bag
Total Weight	7.5 lb (3.4 kg)

Kodiak Peak II -5°F / -20°C

Insufil®
THERMO



Product # 20460

The Kodiak Peak is great for outdoor winter pursuits, when temperatures are not quite so extreme. Expedition-ready features such as Insufil® Thermo insulation, ergonomic head gasket and foot box, draft tubes and neck collar. Available with left or right zippers, and may be zipped together with other compatible bags.

Size	90" x 34" x 22" (229 x 86 x 56 cm)
Shape	mummy
Construction	three layer shingle design
Outer Shell	nylon
Lining	polyester pongee
Filling	4 lb (1800 g) of Insufil Thermo
Zipper	#8 YKK 2-Way, 65" reversible, auto-lock
Stuff Sack	cap compression bag
Total Weight	5.3 lb (2.4 kg)

Kodiak Lite 14°F / -10°C

Insufil®
THERMO



Product # 20470

The Kodiak Lite is great addition to our Chinook line. Ideal for spring and fall outings. Insufil® Thermo insulation ergonomic. Head gasket and foot box, draft tubes and neck collar. Available with right or left zippers, and may be zipped together with other compatible bags.

Size	90" x 34" x 22" (229 x 86 x 56 cm)
Shape	mummy
Construction	two layer shingle design
Outer Shell	nylon
Lining	polyester pongee
Filling	2.4 lb (1100 g) of Insufil Thermo
Zipper	#8 YKK 2-Way, 65" reversible, auto-lock
Stuff Sack	cap compression bag
Total Weight	3.7 lb (1.7 kg)

Everest Comfort II 15°F / -10°C

INVISTA®

THERMOLITE®

More leg room



Product # 20622

The Everest Comfort was specifically designed for outdoor enthusiasts who want more leg room along with the performance of a cold-weather sleeping bag. Chinook uses Insufil Thermo insulation to create this roomy and comfortable sleeping bag. Great for trips in the late autumn or early spring, when the temperature is still below the freezing point.

Size	(80" + 12") x 34" ((203 + 30) x 86 cm)
Shape	hooded rectangular
Construction	two layer
Outer Shell	nylon
Lining	polyester pongee
Filling	1.8 lb (800 g) of invista Thermolite Hollofil
Zipper	#5 YKK 2-way, 117" long
Stuff Sack	4-way compression bag
Total Weight	4.3 lb (1.95 kg)



Super light & compact

A ThermoPalm is the perfect choice for the space-conscious world traveler who wants to pack light. These very roomy and comfortable styles will compress down to an extremely small and lightweight package. Insufil® Thermo technology provides high loft and exceptional warmth making bags soft, lightweight and compact. The Insufil® fibers are bonded using a special heating process that produces insulation that does not clump and fibers that do not separate during use.

ThermoPalm Mummy

Insufil®
THERMO

50°F / 10°C

32°F / 0°C

	20300GY (Grey)	20333 (Blue)
Product #	20300GY (Grey)	20333 (Blue)
Size	83" x 30" x 20" (210 x 75 x 50 cm)	
Shape	mummy	
Construction	one layer	two layer
Outer Shell	polyester taffeta	polyester ripstop
Lining	polyester pongee	
Filling	6 oz (170 g) of Insufil Thermo	12 oz (340 g) of Insufil Thermo
Zipper	#5 2-Way, 67"	
Stuff Sack	4-way compression bag	
Total Weight	1.3 lb (0.6 kg)	1.8 lb (0.8 kg)

ThermoPalm Hooded Rectangular

Insufil®
THERMO

50°F / 10°C

32°F / 0°C

	20322 (Blue)	20348 (Blue)
Product #	20322 (Blue)	20348 (Blue)
Size	(78" + 12") x 32" ((198 + 30) x 81 cm)	
Shape	hooded rectangular	
Construction	one layer	two layer
Outer Shell	polyester taffeta	
Lining	polyester pongee	
Filling	7.4 oz (210 g) of Insufil Thermo	14.8 oz (420 g) of Insufil Thermo
Zipper	#5 2-Way, 78"+36"	
Stuff Sack	4-way compression bag	
Total Weight	1.9 lb (0.84 kg)	2.4 lb (1.1 kg)

ThermoPalm Rectangular

Insufil®
THERMO

50°F / 10°C

32°F / 0°C

	20310OL (Olive)	20343 (Blue)
Product #	20310OL (Olive)	20343 (Blue)
Size	78" x 32" (198 x 81 cm)	
Shape	rectangular	
Construction	one layer	two layer
Outer Shell	polyester taffeta	
Lining	polyester pongee	
Filling	6.3 oz (180 g) of Insufil Thermo	12.6 oz (360 g) of Insufil Thermo
Zipper	#5 2-Way, 78"+36"	
Stuff Sack	4-way compression bag	
Total Weight	1.8 lb (0.81 kg)	2.2 lb (1.0 kg)

ThermoPalm Large Rectangular

Insufil®
THERMO

50°F / 10°C

32°F / 0°C

	20324 (Blue)	20353 (Blue)
Product #	20324 (Blue)	20353 (Blue)
Size	82" x 36" (208 x 91 cm)	
Shape	rectangular	
Construction	one layer	two layer
Outer Shell	polyester taffeta	
Lining	polyester pongee	
Filling	9.2 oz (260 g) of Insufil Thermo	1.1 lb (520 g) of Insufil Thermo
Zipper	#5 2-Way, 82"+39"	
Stuff Sack	4-way compression bag	
Total Weight	2.0 lb (0.8 kg)	2.7 lb (1.2 kg)



- » Perfect for the space-conscious backpacker bound for warm and tropical climates.
- » Very roomy and comfortable, these bags will compress down to a small and lightweight package using the 4-way compression sack.

ThermoPalm Mummy NEW

Insufil®
THERMO



15°F / -10°C

-5°F / -20°C

Product #	20371 (Green)	20381 (Orange)
Size	83" x 30" x 20" (210 x 75 x 50 cm)	
Shape	mummy	
Construction	two layers (top) & one layer (bottom)	
Outer Shell	polyester taffeta	
Lining	polyester pongee	
Filling	1.7 lb (790 g) of insufil Thermo	2.1 lb (950 g) of insufil Thermo
Zipper	#5 2-way, 78"+36"	
Stuff Sack	4-way compression bag	
Total Weight	3.4 lb (1.5 kg)	3.7 lb (1.7 kg)

ThermoPalm Hooded Rectangular NEW

Insufil®
THERMO



15°F / -10°C

-5°F / -20°C

Product #	20370 (Green)	20380 (Orange)
Size	(78" + 12") x 32" ((198+30) x 81 cm)	
Shape	hooded rectangular	
Construction	two layers (top) & one layer (bottom)	
Outer Shell	polyester taffeta	
Lining	polyester pongee	
Filling	2.5 lb (1120 g) of insufil Thermo	3.3 lb (1480 g) of insufil Thermo
Zipper	#5 2-way, 78"+36"	
Stuff Sack	4-way compression bag	
Total Weight	4.5 lb (2.05 kg)	5.3 lb (2.42 kg)

Superlite Rectangular

Insufil®1



45°F / 7°C

Product #	20403
Size	75" x 33" (191 x 84 cm)
Shape	rectangular
Construction	one layer
Outer Shell	polyester taffeta
Lining	polyester pongee
Filling	8 oz (230 g) of Insufil 1
Zipper	67" long
Stuff Sack	4-way compression bag
Total Weight	2 lb (0.92 kg)

Superlite Hooded Rectangular

Insufil®1



45°F / 7°C

Product #	20408
Size	(75" + 12") x 33" ((191 + 30) x 84 cm)
Shape	hooded rectangular
Construction	one layer
Outer Shell	polyester ripstop
Lining	polyester pongee
Filling	11 oz (300 g) of Insufil 1
Zipper	67" long
Stuff Sack	4-way compression bag
Total Weight	2.5 lb (1.12 kg)



Alaskan 9.5 Double XL **-50°F / -45°C**

Insufil®4

Oversized

These rugged oversized Multi-Season System bags are a perfect choice for any cold-weather hunting or camping trip. The Alaskan 9.5 features our practical 3-in-1 Multi-Season System.

- » 2 layers of Insufil 4 hollow fiber for superior warmth
- » Zippered hood and liner for easy removal and washing
- » Outer shell is made of heavy-duty polycotton canvas
- » Water-resistant duffel bag is included

3-in-1 Multi-Season System:

1 sleeping bag, 3 uses.

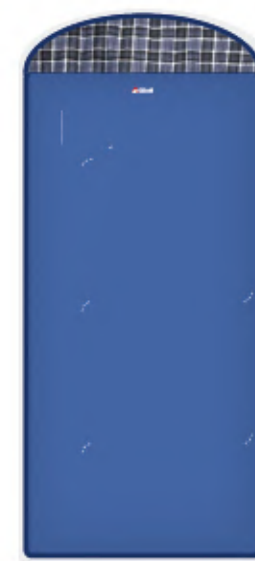

1 4-season single bag

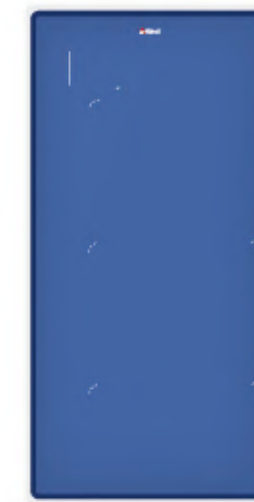

2 2 individual sleeping bags



OR



3 Extra roomy zip-together 2-person bag



Product # 20960 (Blue) 20962 (Green)

Size	87" x 42" (220 x 107 cm)
Shape	rectangular with removable hood
Construction	2 detachable insulated bags
Outer Shell	heavy duty poly-cotton canvas
Lining	polyester pongee with detachable flannel liner
Filling	outer bag: 6 lb (2700 g); inner bag: 3.5 lb (1600 g); total: 9.5 lb (4300 g) of Insufil 4
Zipper	main: #10 heavy duty 2-way; inner: #8 & #5
Stuff Sack	heavy duty water-resistant duffel bag
Total Weight	29.8 lb (13.5 kg)

The Beast Double XL **-40°F / -40°C**

Insufil®4

Oversized



Product # 45501

Size	87" x 42" (220 x 107 cm)
Shape	rectangular
Construction	1 bag + detachable insulated lining
Outer Shell	heavy duty poly-cotton canvas
Lining	polyester pongee with detachable flannel liner
Filling	6.8 lb (3100 g) of Insufil 4
Zipper	#10 heavy duty 2-way
Stuff Sack	heavy duty duffel bag
Total Weight	22.5 lb (10.2 kg)

Huntsman Extra Large -22°F / -30°C

Insufil®4

Oversized



NORTHWOODS OUTFITTERS SERIES - INSUFIL® 4 FILL



Product # 43405

The Huntsman bag will give the hunter a good night's sleep to maintain a sharp outlook for the next day in the bush. Features like an extra-wide cut with high loft Insufil@4 insulation, a camo polyester top, polycotton canvas bottom, polyester pongee liner and a hood with built-in pillow make this another great hunting partner, providing excellent comfort and protection against the cold.

Size	(80" + 15") x 42" ((203 + 38) x 107 cm)
Shape	hooded rectangular
Construction	two layer
Outer Shell	top: camo polyester; bottom: polycotton canvas
Lining	polyester pongee
Filling	6.2 lb (2800 g) of Insufil 4
Zipper	#8 open end
Stuff Sack	duffel bag
Total Weight	12 lb (5.5 kg)





Get a great sleep in the great outdoors in one of these extra-wide and thermally efficient bags. Practical, warm and affordable, this series is perfect for the outdoorsman who depends on his gear in tough conditions.



Woodland 8 Extra Large **-22°F / -30°C**
Insufil®1



Oversized

TRAILSIDE

Product # 27485

Size	87" x 42" (220 x 107 cm)
Shape	rectangular
Construction	two layer
Outer Shell	poly-cotton canvas
Lining	soft flannel
Filling	8 lb (3650 g) of Insufil 1
Zipper	#8 heavy-duty 2-way
Stuff Sack	water-resistant duffel bag
Total Weight	11.6 lb (5.2 kg)

Sportsman 5 Extra Large **0°F / -18°C**
Insufil®1



Oversized

TRAILSIDE

Product # 27356

Size	84" x 40" (213 x 102 cm)
Shape	rectangular
Construction	two layer
Outer Shell	poly-cotton
Lining	soft flannel
Filling	5 lb (2300 g) of Insufil 1
Zipper	#8 heavy-duty 2-way
Stuff Sack	water-resistant duffel bag
Total Weight	7.9 lb (3.6 kg)



These bags were designed with comfort, warmth and good old-fashioned value in mind. We have used high-performance Insufil 1 Hollow Fiber insulation which has excellent heat retention and thermal properties to ensure a great night's rest. Perfect for getaways to the campground, cottage or hunting lodge, these bags will suit any family's needs.

Dawson 6 Extra Large **-15°F / -26°C**

Insufil®1

Oversized



TRAILSIDE

Product # 27265

Size	(80" + 12") x 40" ((203 + 30) x 102 cm)
Shape	hooded rectangular
Construction	two layer
Outer Shell	polyester taffeta
Lining	soft flannel
Filling	6 lb (2700 g) of Insufil 1
Zipper	durable #8 2-way
Stuff Sack	standard
Total Weight	8.5 lb (3.9 kg)

Dawson 9 Extra Large **-31°F / -35°C**

Insufil®1

NEW

Oversized



TRAILSIDE

Product # 27295

Size	(80" + 12") x 40" ((203 + 30) x 102 cm)
Shape	hooded rectangular
Construction	two layers
Outer Shell	polyester taffeta
Lining	soft flannel
Filling	9 lb (4080 g) of insufil 1
Zipper	durable #8 2-way
Stuff Sack	heavy duty duffle bag
Total Weight	12.3 lb (5.6kg)

Sundowner 3 **27°F / -3°C**

Insufil®1



TRAILSIDE

Product # 27235

Size	(80" + 12") x 34" ((203 + 30) x 86 cm)
Shape	hooded rectangular
Construction	two layer
Outer Shell	polyester taffeta
Lining	polyester pongee
Filling	3 lb (1350 g) of Insufil 1
Zipper	#5 2-way
Stuff Sack	standard
Total Weight	5.0 lb (2.2 kg)

Sundowner 5 **5°F / -15°C**

Insufil®1



TRAILSIDE

Product # 27256

Size	(80" + 12") x 34" ((203 + 30) x 86 cm)
Shape	hooded rectangular
Construction	two layer
Outer Shell	polyester taffeta
Lining	polyester pongee
Filling	5 lb (2250 g) of Insufil 1
Zipper	#5 2-way
Stuff Sack	standard
Total Weight	7.3 lb (3.3 kg)



2 LAYERS INSUFIL® 1 SERIES

Treeline 2 32°F / 0°C

Insufil®1



TRAILSIDE

Product # 27221

Size	80" x 34" (203 x 86 cm)
Shape	rectangular
Construction	two layer
Outer Shell	polyester taffeta
Lining	polyester pongee
Filling	2 lb (900 g) of Insufil 1
Zipper	#5 2-way
Stuff Sack	standard
Total Weight	3.8 lb (1.7 kg)

Treeline 4.5 14°F / -10°C

Insufil®1



TRAILSIDE

Product # 27241

Size	80" x 34" (203 x 86 cm)
Shape	rectangular
Construction	two layer
Outer Shell	polyester taffeta
Lining	polyester pongee
Filling	4.4 lb (2000 g) of Insufil 1
Zipper	#5 2-way
Stuff Sack	standard
Total Weight	6 lb (2.7 kg)

Treeline 6 -4°F / -20°C

Insufil®1



TRAILSIDE

Product # 27251

Size	80" x 34" (203 x 86 cm)
Shape	rectangular
Construction	two layer
Outer Shell	polyester taffeta
Lining	polyester pongee
Filling	6 lb (2700 g) of Insufil 1
Zipper	#5 2-way
Stuff Sack	standard
Total Weight	7.6 lb (3.5 kg)





FOR WOMEN

Victoria 20°F / -7°C
Insufil®
THERMO



Women 3-season synthetic sleeping bag.

Product #	27252
Size	83" x 29" x 19" (210 x 74 x 49 cm)
Shape	mummy
Construction	two layer
Outer Shell	nylon + polyester
Lining	polyester
Filling	2.7 lb (1230 g) of Insufil Thermo
Zipper	#5 2-way
Stuff Sack	compression bag
Total Weight	3.9 lb (1.75 kg)

Dream Weaver 5°F / -15°C
DOWN



Women 3-season 600 down sleeping bag.

Product #	27253
Size	83" x 31" x 22" (210 x 80 x 55 cm)
Shape	mummy
Construction	horizontal channel design
Outer Shell	nylon + polyester
Lining	polyester
Filling	1.87 lb (850 g) of JIS 90/10 FP650 GGD
Zipper	#5 2-way
Stuff Sack	compression bag
Total Weight	4.3 lb (1.94 kg)



Chinook designed these premium sleeping bags specifically for the young adventurers in the family. These kid-sized sleeping bags have all the same great features found in our top-line adult sleeping bags. We have the right bag for any camp, cottage or scouting activity.

Kids 32°F / 0°C
Insufil®1



Product # 12242 (Blue) 20750 (Cyan) 20761 (Pink)

This scaled-down version of a grown up bag has many of the same great features, including Insufil® 1 insulation, ergonomic head gasket and foot box, draft tubes, hood with built-in pillow and external pocket.

Size	71" x 28" x 22" (180 x 72 x 55 cm)
Shape	hooded tapered
Construction	one layer
Outer Shell	polyester taffeta
Lining	polyester pongee
Filling	1.5 lb (700 g) of Insufil 1
Zipper	#5 2-way
Stuff Sack	standard
Total Weight	2.80 lb (1.3 kg)

Cubs 32°F / 0°C
Insufil®1



Product # 20789 (Green) 20794 (Pink)

Size	55" x 23" x 18" (140 x 58 x 46 cm)
Shape	hooded rectangular
Construction	one layer
Outer Shell	polyester taffeta
Lining	polyester pongee
Filling	1.3 lb (600 g) of Insufil 1
Zipper	#5 2-way
Stuff Sack	standard
Total Weight	2.1 lb (0.97 kg)



Scout Junior 32°F / 0°C

Insufil®1



Product # 27216

Size	75" x 30" x 20" (190 x 75 x 50 cm)
Shape	mummy
Construction	two layer
Outer Shell	polyester taffeta
Lining	polyester pongee
Filling	1.5 lb (700 g) of Insufil 1
Zipper	#5 2-way
Stuff Sack	standard
Total Weight	2.6 lb (1.17 kg)

Trekker 5°F / -15°C

Insufil®
THERMO



Product # 11504

Chinook took extra effort in designing a technical mummy bag specifically for the young adventurers in the family. This scaled down version has all the great features found in our other expedition bags, including Insufil Thermo insulation, ergonomic head gasket and foot box, draft tubes and neck collar.

Size	75" x 30" x 22" (190 x 75 x 55 cm)
Shape	mummy
Construction	two layers
Outer Shell	polyester taffeta
Lining	polyester pongee
Filling	1.52 lb (710 g) of Insufil thermo
Zipper	#5 2-way
Stuff Sack	4-way compression bag
Total Weight	3.3 lb (1.5 kg)

Tadpole Junior II 36°F / 2°C

Insufil®1



Product # 27112

Size	60" x 27" (152 x 69 cm)
Shape	rectangular
Construction	one layer
Outer Shell	polyester taffeta
Lining	polyester pongee
Filling	1.5 lb (700 g) of Insufil 1
Zipper	#5 2-way
Stuff Sack	standard
Total Weight	2.5 lb (1.13 kg)

Young Camper 32°F / 0°C

Insufil®1



Product # 20770 (Blue) 20771 (Red)

Size	65" x 27" x 20" (165 x 69 x 51 cm) length expands 12" (30 cm)
Shape	mummy
Construction	one layer
Outer Shell	polyester taffeta
Lining	polyester pongee
Filling	1.5 lb (700 g) of Insufil 1
Zipper	#5 2-way
Stuff Sack	standard
Total Weight	2.7 lb (1.23 kg)





Sleeping Accessories



Snugly Blanket **NEW**

Product #	22122 (Blue Camo)	22123 (White Camo)	22124 (Blue)
Size	Extended: 55" x 85" (140 x 216 cm)		Pillow: 18" x 12" (45 x 30 cm)
Material	(Shell) Polyester Taffeta / (Lining) Polyester Pongee		
Features	<ul style="list-style-type: none"> » Converts to Poncho Style » Built-In Foot Box » Built-In Pillow Converter » Carry Bag Included » Machine Washable 		
Weight	1.9 lb (875 g)		





Microfleece Sleeping Bag Rectangular & Mummy



A versatile addition to your camping gear or travel pack.

- » Very soft, non-pilling microfleece.
- » Perfect for balmy nights when a sleeping bag is too warm.
- » Adds extra insulation when combined with a sleeping bag.
- » Helps keep the interior of your sleeping bag clean.
- » Stuffs down into a very lightweight, compact package (stuff sack included).

Product #	27000 (Rectangular)	27007 (Mummy)
Size	75" x 33" (190 x 84 cm)	(78" + 12) x 32" (198 + 30) x 81 cm
Material	Non-pilling fleece	
Zipper	#5 2-way	
Stuff Sack	standard	
Total Weight	1.25 lb (0.6 kg)	

Pongee Sleeping Bag Liner Rectangular & Mummy & Oversize



A versatile addition to your camping gear or travel pack.

- » Very soft, silk-like polyester fabric.
- » Helps keep the interior of your sleeping bag clean.
- » Can be used on its own on warmer nights.
- » Stuffs down into a very lightweight, compact package (stuff sack included).



Product #	22106 (Mummy)	22111 (Rectangular)	22115 (Oversize)
Size	83" x 30" x 20" (210 x 75 x 50 cm)	78" x 32" (198 x 81 cm)	84" x 84" (214 x 214 cm)
Material	100% polyester		
Total Weight	7.4 oz (210 g)	9.5 oz (270 g)	13.65 oz (387 g)

Flannel Liner



Product # 00010RE (Red)

- » Comes with a nylon carry bag.
- » Helps keep the interior of your sleeping bag clean.
- » Adds extra warmth and comfort to a sleeping bag.

Size	78" x 34" (198 x 86 cm)
Shape	rectangular
Material	100% flannel cotton

Hostel Sheet



Product # 03201

- » Can be used as a sleeping bag liner.
- » Helps keep the interior of your sleeping bag clean.
- » Can be used on its own on warmer nights.

Size	(85" + 10") x 34" ((215 + 25) x 86 cm)
Shape	rectangular with hood
Material	100% cotton

Compression Bag



Product #	00005 (Small)	00006 (Medium)	00007 (Large)
Size	19.5" x 7.5" (50 x 19 cm)	23.5" x 8.5" (60 x 22 cm)	29" x 10" (74 x 25 cm)
Material	oxford nylon		
Features	<ul style="list-style-type: none"> » Reinforced cap compression system. » Four compression straps with bar tacks for extra durability. » Two web straps with quick-release buckles for convenience. 		



MATS & PILLOWS

• Open package & leave valve open for 24 hours

ChinookRest Deluxe Self-Inflating Mattress



These super comfortable, self-inflating mattresses are ideal for any backpacking excursion or family camping trip. They provide superior warmth, comfort and support in a portable design to ensure a good night's sleep wherever you decide to call it a night.

- » Top Fabric: :150D Brushed peach polyester TPU fabric
- » Bottom Fabric: Grey polyester pongee TPU
- » Durable valve for quick and easy inflation and deflation
- » Sponge: Cellular lattice for rapid inflation/deflation, excellent insulation and extra comfort on rough or uneven surfaces
- » Comes with a carry bag and repair kit

Product #	23032 (Regular)	23047 (XL)
Size	72" x 20" (183 x 51 cm)	78" x 25" (198 x 63 cm)
Thickness	2" (5 cm)	2" (5 cm)
R-Value	6	6
Weight	2 lb 3 oz (995 g)	3 lb (1350 g)

GuideRest Lite Self-Inflating Mattress



These lightweight and very compact technical mats are ideal for mountaineering and backpacking trips.

- » Die-cut open-cell foam for rapid inflation/deflation, excellent insulation and extra comfort on rough or uneven surfaces
- » Top Fabric: Lightweight and durable, TPU-coated diamond ripstop nylon fabric with an anti-slip surface to help reduce sleeping bag slippage
- » Bottom Fabric: Heavy-duty, TPU coated nylon with a non-slip surface
- » Top quality, super strong brass valve for quick and easy inflation and deflation. Will not break in sub-zero weather
- » Comes with a stuff sack and repair kit

Product #	23052 (3/4 Length)	23057 (full length)
Size	48" x 20" (122 x 51 cm)	72" x 20" (183 x 51 cm)
Thickness	1.5" (3.8 cm)	
R-Value	3.2	
Weight	1 lb 5 oz (608 g)	1 lb 13 oz (827 g)

EVA LiteMat foam Pad



- » Ultralight closed-cell EVA foam pad.
- » Provides insulation and comfort under any sleeping bag.
- » The tough foam stands up to cold temperatures as low as -60°F without cracking or becoming brittle.

Product #	29007 (Large)	29009 (XL)
Size	76" x 26" x 0.625" (193 x 66 x 1.6 cm)	76" x 26" x 1" (193 x 66 x 2.5 cm)



TrailRest Double-Wide Self-Inflating Mattress



These 2-person double-wide mats are a great choice for any couple, adding extra comfort and insulation while in camp. Warmer and more comfortable than air-mattresses, cots or closed-cell foam pads, these terrific all-purpose mattresses are perfect for car camping trips or at the cottage. They offer all the same great features as our single mats.

- » Fully bonded foam-fabric construction
- » Two extra-large high-flow air valves for rapid inflation and deflation
- » Comes with a stuff sack and web straps for easy packing and storage
- » Includes handy repair kit

Product #	29210 (Regular)	29215 (Large)	29220 (X-Large)
Size	72" x 48" (183 x 122 cm)		
Thickness	1.2" (3 cm)	2" (5 cm)	3" (7.6 cm)
R-Value	3	6.2	7.2
Weight	5 lb 11 oz (2.6 kg)	7 lb 11 oz (3.5 kg)	9 lb 14 oz (4.5 kg)

TrailRest Regular Self-Inflating Mattress



Terrific all-purpose mattresses for backpacking and car camping trips, adding extra comfort and insulation while in camp.

- » Fully bonded foam-fabric construction
- » Single high-flow air valve
- » Comes with a stuff sack and web straps for easy packing and storage
- » Includes handy repair kit

Product #	29111 (Regular)	29116 (Large)	29120 (X-Large)
Size	74" x 21.6" (188 x 55 cm)	74" x 26" (188 x 66 cm)	76" x 25" (192 x 63 cm)
Thickness	1.2" (3 cm)	2" (5 cm)	2.5" (6.3 cm)
R-Value	3	6.2	7
Weight	2 lb 14 oz (1.3 kg)	4 lb 6 oz (2.0 kg)	5 lb 4 oz (2.3 kg)

Ultralight XPE / EVA Foam

TrailFoam AiroLite Foam Pad

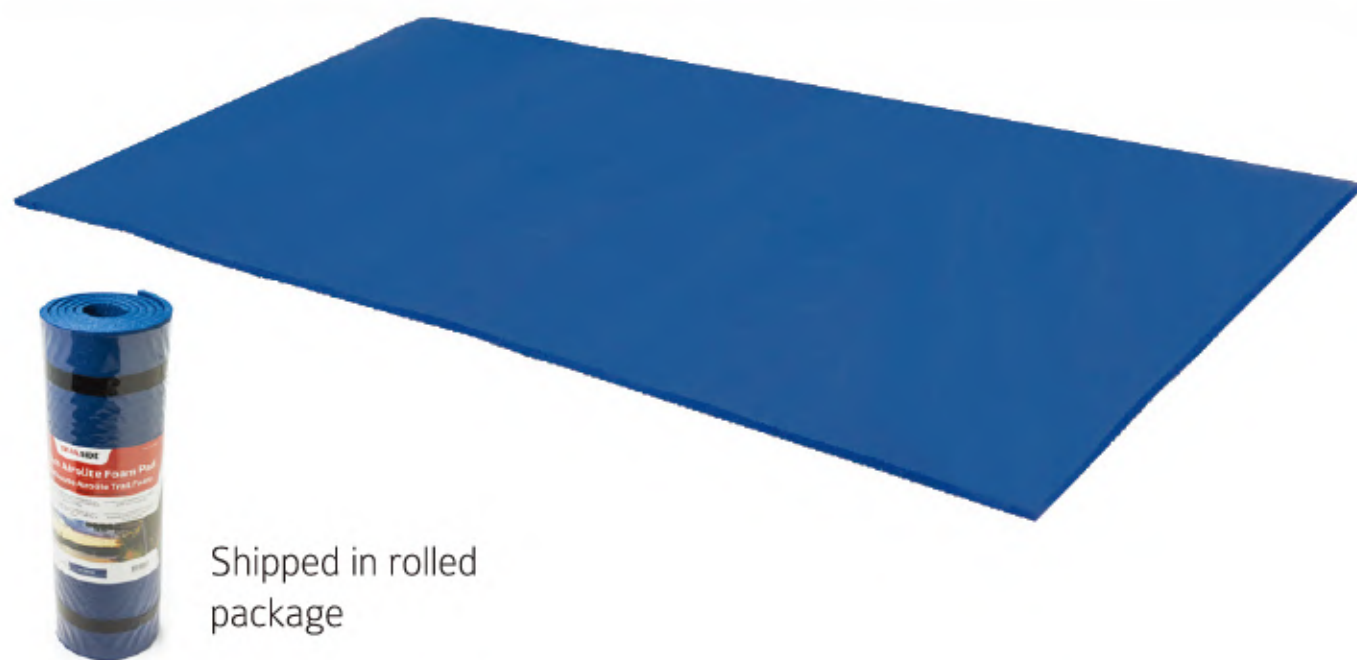

Shipped in rolled package

- » Ultralight closed-cell XPE foam pad.
- » Provides super insulation and comfort under any sleeping bag.
- » The tough, light, blue foam stands up to cold temperatures as low as -60°F without cracking or becoming brittle.

Product # 29023 (Blue)
Size: 72" x 20" x 0.375"
(183 x 50 x 1 cm)

Product # 29025 (Green) 
Size: 72" x 27" x 0.375"
(183 x 68 x 1 cm)

EVA Mat with Aluminum Film



- » Ultralight closed-cell EVA foam pad.
- » Provides super insulation and comfort under any sleeping bag.
- » The tough, light, blue foam stands up to cold temperatures as low as -60°F without cracking or becoming brittle.

EVA Mat with Aluminum Film
Product # 29033
Size: 70" x 20" x 0.5" (180 x 50 x 1.2 cm)



Pillows

Self-Inflating Contour Pillow



Product # 23004

- » Ultra-lightweight, full-size travel pillow
- » Countour shape provides super comfortable head and neck support
- » Ultra-soft stretch knit fabric is soft against the skin
- » Packs down into a small stuff sack

Size	20" x 12.6" x 4.7" (51 x 32 x 12 cm)
Material	Stretch knit and TPU coated polyester

ChinookRest Self-Inflating Cushion/Pillow



Product # 23000

- » Super comfy, lightweight and packable.
- » Comes with a nylon stuff sack.

Size	16" x 12" x 3" (40 x 30 x 7 cm)
Material	TPU coated ripstop nylon with bonded lightweight foam.

Dreamer II Deluxe Self-Inflating Pillow



Product # 23002

- » Maximum comfort in a lightweight, compact package.
- » Easy-use valve for custom adjustment.
- » Non-slip bottom.
- » Built-in straps.
- » Comes with a nylon stuff sack.

Size	20" x 12" x 6" (51 x 30 x 15 cm)
Material	Heavy-duty polyester and foam chips

TPU Inflatable Pillows **NEW**



	Rectangular
Product #	28020
Size	16.5" x 12.5" x 4" (42 x 32 x 10 cm)
Weight	84 g



	Pea Shape
Product #	28021
Size	16.5" x 12.5" x 4.3" (42 x 32 x 11 cm)
Weight	78 g



	Travel Neck
Product #	28022
Size	14" x 12" x 4.3" (36 x 31 x 11 cm)
Weight	53 g

- » Soft Stretch TPU fabric
- » Spring Valve for custom comfort
- » Inflates in seconds
- » Super lightweight





Thermo Travel Pillow

Insufil®
THERMO



Product # 22031

- » Large pocket for extra stuffing.
- » Built-in stuff sack.
- » Stuffs down to a very compact size.

Size	17" x 13" (43 x 33 cm)
Material	nylon / polycotton
Filling	Insufil Thermo

Down Pillow



Product # 22050

- » Invista Tactel Diamond ripstop stuff sack.
- » Removable pillowcase can be filled with extra stuffing (fleece, sweater).

Size	17" x 13" (43 x 33 cm)
Material	pongee
Filling	80/20 duck down, 500 fill power

Flannel Pillow Rectangular & Square



Product #	28005 (Rectangular)	28010 (Square)
Size	18" x 10" (46 x 25 cm)	17" x 17" (43 x 43 cm)
Material	polyester/flannel	
Filling	polyester fiber	
Includes	stuff sack	

Microfleece Pillow Rectangular & Square



Product #	28007 (Rectangular)	28013 (Square)
Size	18" x 10" (46 x 25 cm)	17" x 17" (43 x 43 cm)
Material	microfleece polyester	
Filling	polyester fiber	
Includes	stuff sack	

Camp Pillow Rectangular & Square



Product #	01717 (Square)
Size	17" x 17" (43 x 43 cm)
Material	nylon/cotton
Filling	polyester fiber
Includes	stuff sack





FURNITURE



Heavy Duty Padded Outfitter Cot



Product # [29250](#)

Camping Luxury... The ultimate bed for camp or cottage.

- » Quick, hassle-free setup - just unfold and it's ready to use.
- » Adjustable backrest settings.
- » Padded sleeping surface with built-in pillow for superior comfort and warmth.
- » Heavy duty welded aluminum frame with height adjustment system.
- » 600-denier nylon fabric throughout for lasting performance.
- » Folds up compactly for easy transportation and storage.

Size: 83.5" x 33" x 20" (212 x 82 x 51 cm)





Hybrid Lite Cot **NEW**

Product # 29234

Size: 75" x 26" x 15" (190 x 65 x 38 cm)

Packing size: 6.3" x 22" (16 x 55 cm)

- » 7001 Aircraft Aluminum Alloy
- » 600D Ripstop Polyester
- » Locking Lever System easily tensions the sleeping surface
- » Integrated Mattress Straps to keep optional mat in place
- » Includes Carry Bag which can be attached to cot while in use for storage
- » Removable legs
- » 15" (38 cm) high with legs, 7" (17 cm) high no legs

Weight: 6.8 lb (3.1 kg)

Capacity: 330 lb (150 kg)



Backpacking Bed

Product # 09101

Lightweight cot that gets you off the ground. Alloy frame is sturdy, strong, and lightweight. Lever system easily tensions the sleeping surface. Included storage sack for easy transport.

Size: 74.8" x 24.8" x 7.1" (190x63x18cm)

Weight: 5.18 lbs (2.35 kg)

Capacity: 265 lbs (120 kg)



Aluminum Camp Cot

Product # 09009 **Size:** 82" x 32" x 18" (208 x 81 x 46 cm) **Weight:** 18.7 lbs (8.5 kg)

Product # 29236 **Size:** 82" x 36" x 21" (208 x 92 x 53 cm) **Weight:** 19.8 lbs (9 kg)

Ideal for camping, at the beach or at home as a guest bed.

- » Extremely lightweight and sturdy aluminum X-frame.
- » 600-denier polyester fabric for lasting performance.
- » Folds up compactly for easy transportation and storage.
- » Color: Forest Green
- » Includes carry bag.





Camp Seating

Canoe Seat

Product # 04301

Enjoy the great outdoors in greater comfort with our Canoe Seat. A sturdy strapping system secures to a standard canoe seat. This lightweight seat will give you great back support for long canoeing trips.

Size: 15" x 27" x 0.5" (38 x 69 x 1.3 cm)

Material: 600D polyester



Comfy Chair Kit 25"



In only a few seconds you can convert a Chinook 25" wide self-inflating air mat into a comfy chair. This ultra comfortable seat with adjustable back support will make your next camping or paddling trip a relaxing one. Can be used with most other 25" wide mats and pads. (Mat not included)

Product #	23155 (25")
Size	26" x 38" (66 x 97 cm)
Material	210D oxford nylon
Compatible with these mats	ChinookRest (#23046) TrailRest (#29120)

Allpurpose Chair



Product # 09211

Aluminum 7075 lightweight folding camp or backpacking chair. Sets up quickly and easily. Single shock corded pole structure. Breathable mesh on sides.

Size: 20" x 25" x 5.7" (51 x 63.5 x 14.5 cm)

Weight: 1.7 lbs (752 g)

Capacity: 220 lbs (100 kg)

Allterrain Chair

Product # 23110

The Allterrain Chair is perfect for use at campsites, concerts, sporting events or the lakeshore. This chair has wide stays and easily adjustable side straps for custom comfort and extra back support.

Size: 15.5" x 33" x 0.5" (40 x 84 x 1.3 cm)

Material: 600D ripstop polyester



Tripod (Aluminum) Folding Stool For Kids 100 Lbs



Product # 09007

Tripod folding stools with a 600D brushed polyester seat and carry strap. Features a super lightweight aluminum frame.

Size: 13.5" x 13.5" x 16" (34 x 34 x 40 cm)

Kids: 100 lbs

Tripod Folding Stool (Steel)



Product # 09008

Tripod folding stools with a 600D brushed polyester seat and carry strap. Features a sturdy steel frame.

Size: 13.5" x 13.5" x 18" (34 x 34 x 46 cm)



PACKS



Chinook Packs

- Ergonomic comfort
- Load-carrying reliability
- Top quality materials

Feature Highlights

- Top-quality buckles, heavy duty zippers, incredibly comfortable breathable foam back panels and rugged, lightweight fabrics
- All stress points are bar-tacked or triple-stitched for added strength
- Inside seams of all main compartments are nylon-taped for added seam integrity
- Most packs accept hydration systems and feature pockets for electronics such as smartphones and MP3-players

Vector 75 Expedition Pack



Product # 31418BK (Black) 31418OR

- » 600D HDTEX Dobby polyester.
- » Large capacity top loading main compartment.
- » Inner mesh organizer panel for easy access to important items.
- » Separate lower sleeping bag compartment with zippered divider to keep gear organized and balanced.
- » Hydration bladder pocket with dual hose outlet.
- » Heavy duty, #10 nylon coil zipper on the three main compartment openings.
- » Premium thermo-moulded shoulder straps with easy-to-adjust deluxe Air-Flow back panel.
- » Extra-large front pocket panel with a multi-compartment field organizer and zippered mesh panel.
- » Daisy chains and ice-axe loops for securing equipment.
- » External storage options: 4 zippered side pockets, 2 mesh side pockets and waist pouch pocket.

Size: 4575 in³ (75 L)



Orca 60 **NEW**

- » Padded Ventilated Foam Back Support
- » Built-in Raincover
- » Detachable Top Lid Converts to Daypack
- » Heavy Duty #10 & #8 Zippers
- » 2 Side Mesh Pockets, Front Mesh Pocket
- » Hydration Compatible
- » Roll Top Closure
- » 3 Way Entry



Product #	31542 (Grey)	31543 (Lavender)
Size	30" x 15" x 10" (76 x 38 x 25 cm) , 60 L + 5 L	
Material	420D HD Bottom, 210D Ripstop Nylon	
Hip Belt	Medium # 31545	

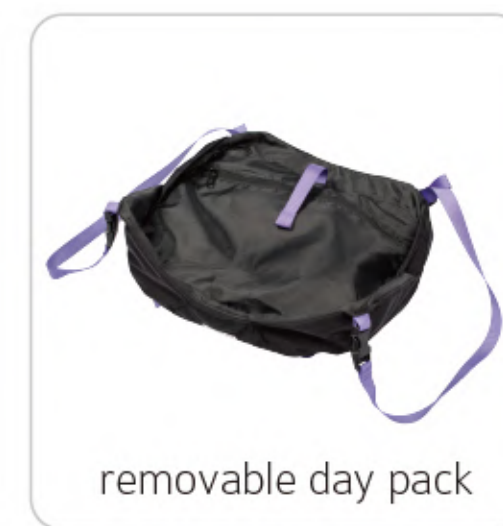
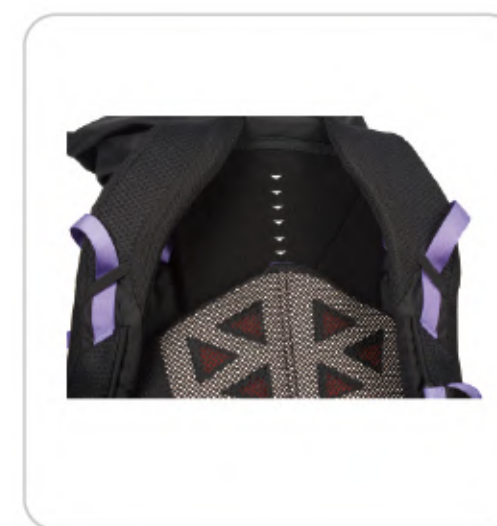

removable day pack

Shasta 75 Expedition Pack



Product # 31425BU

- » 600D HDTEX Diamond ripstop polyester, 600 HDTEX Polyester.
- » Large capacity top loading main compartment.
- » Hydration bladder pocket with dual hose outlet.
- » Heavy duty, #10 nylon coil zipper on lower opening.
- » Torso adjustment and adjustable stabilizer straps.
- » Hide away waterproof rain covers.
- » Padded back and shoulder straps with Air-Flow mesh and adjustable webbing.

Size: 4575 in³ (75 L)



Excursion 80 Travel Pack



Detachable daypack & lumbar pack

- » 600D HDTEX ripstop polyester, 1200D HDTEX Polyester bottom.
- » Internal frame with anodized aluminum stays.
- » Very practical zip-off, combination toiletry bag and lumbar pack.
- » 22 L, Zip-off daypack with front document pocket.
- » Zippered, hide away rigging cover converts this pack into a suitcase style bag.
- » Large capacity top loading main compartment with lower zippered compartment access.
- » Heavy duty, #10 waterproof nylon coil zipper on 2 main compartments.
- » Padded, adjustable back panel for the ultimate in comfort and load support.
- » Padded, hip belt and shoulder straps with sternum strap with adjustable stabilizer straps.
- » Quick-release side compressions for load stabilizing and securing extra gear.
- » Detachable, padded shoulder tote strap.
- » Side and top grab handles.

Excursion 80	
Product #	31645GY (Grey)
Size	4880 + 1340 in ³ (80 + 22 L)

Journey 65 & 75 Travel Pack



Detachable daypack

- » 600D HDTEX ripstop polyester, 600 HDTEX Polyester.
- » Internal frame with anodized aluminum stays.
- » 22L, zip-off daypack with organizer pocket.
- » Large capacity main compartment.
- » Large mesh storage/organizer pocket.
- » Heavy duty, #10 nylon coil zipper all main openings.
- » Torso adjustment and adjustable stabilizer straps.
- » Adjustable, side compression straps.
- » Padded back and shoulder straps with Air-Flow mesh and adjustable webbing.
- » Detachable, padded shoulder tote strap.

	Journey 65	Journey 75
Product #	31625BK (Black)	31629BU (Blue)
Size	3965 + 1340 in ³ (65 + 22 L)	4575 + 1340 in ³ (75 + 22 L)



Overload Duffel Bag 21", 26", 30", 36" & 40"

- » Heavy duty, 600D HDTEX polyester.
- » Very durable duffels that can haul the heaviest loads.
- » Large capacity main compartment.
- » Heavy duty, #10 nylon coil zipper all main openings.
- » Zippered side pocket.
- » Easy grip handles and adjustable shoulder strap.



	21"	26"	30"	36"	40"
Product #	31790BK (Black) 31790NV (Navy)	31792BK (Black) 31792NV (Navy)	31793BK (Black) 31793NV (Navy)	31794BK (Black) 31794NV (Navy)	31795BK (Black)
Size	2540 in ³ (42 L)	4900 in ³ (80 L)	6100 in ³ (100 L)	8540 in ³ (140 L)	11590 in ³ (190 L)

Dlx Pack Cover NEW

- » 210D Oxford Polyester
- » Reflective strip for safety
- » Elastic Cord Lock Tightener
- » Built-In Storage Pouch



	Small	Medium	Large
Product #	32102 (Green) 32112 (Orange)	32104 (Green) 32114 (Orange)	32106 (Green) 32116 (Orange)
Capacity	15-35 L	35-55 L	60-80 L

Allround Pack Cover



Product # 32049 (30L-45L)
32050 (60L & UP)

- » Lightweight, waterproof pack cover
- » Fits most large packs.
- » 210T Taffeta polyester with water polyurethane coating.
- » Easily fits over and secures to most including frame packs.
- » Convenient built-in stuff sack.



Canoe Packs



New Improved

Barrel Harness 60 & 30 L



Product # 31002

- » Great for extended canoe trips.
- » 600D HDTEX ripstop polyester.
- » Padded back panel and shoulder straps with sternum strap for comfort and load support.
- » 3 side compression straps to secure heavy loads.
- » Multiple grab loops, handles and tie points.
- » Accepts 60 L & 30 L barrels (max. circumference 49" / 125 cm).
- » Barrel not included.

Chemun Extreme **NEW**



Product # 04302

Multi-Day, expedition portage pack for extended canoe trips

- » Material: 420H.D. Polyester body+ 600H.D. Polyester bottom
- » 2 side pockets + 2 water bottle pockets
- » 2 Aluminum stays
- » Large top-loading main compartment
- » Fold down dry bag style closure
- » Large mesh envelope pocket on the front of pack
- » Padded back panel and shoulder straps with sternum strap for comfort and load support
- » Padded hip belt with adjustable stabilizer straps
- » Multiple grab loops and handles and tie points

Size: 25" x 18" x 10" (64 x 46 x 25 cm)

Volume: 100 L (6100 In3) 75 L Main body+ 25 L Top extension

Lumbar Packs



Mesh Stuff Sacks

 Yellow  Black * Bulk (10 pieces)

- » See-through super-tough nylon mesh with drawcord and cordlock.
- » Machine-washable.
- » Available in 6 convenient sizes & 2 colors.

	XSmall	Small	Medium	Large	XLarge	XXLarge
Product #	32160 (Black) 32161 (Yellow)	32162 (Black)	32165 (Black)	32167 (Black)	32169 (Black) 32170 (Yellow)	32171 (Black)
Size	5" x 9" (12 x 23 cm)	5" x 12" (12 x 30 cm)	7" x 15" (18 x 38 cm)	10" x 18" (25 x 46 cm)	12" x 30" (30 x 76 cm)	24" x 30" (60 x 76 cm)

Express 2-in-1 Money Belt



Product # 32310BK (Black)

- » 600D HDTEX ripstop polyester and a moisture-wicking fabric back stays cool against skin.
- » Switch between money belt and neck wallet by using the adjustable elasti cized waist belt or neck lanyard. Both can be stored in the hidden back panel.
- » Zippered compartment to store passport, money and other valuables.
- » Available in assorted colors.

Size: 5" x 10" (13 x 25 cm)

Express Organizer Pouch



Product # 32320BK (Black)

- » 600D HDTEX ripstop polyester.
- » Zippered compartment stores a passport, tickets, documents and money.
- » Interior envelope pockets, ID and credit card slots, tote handle.
- » Available in assorted colors.

Size: 10" (15 x 25 cm)

Bottlepack Insulated Bottle Holder



Product # 03901

- » 600D HDTEX Polyester.
- » 2 side pockets with zippers for storage of keys, money etc.
- » 3M Scotchguard reflective strip for high visibility.
- » Water bottle is included.
- » Assorted colors available.



MARINE GEAR

Kayak Deck Bag

These deluxe multi-purpose bags attach easily to kayak decks, and convert to handy carry bags by simply attaching shoulder strap.

- » Large water-resistant main compartments.
- » Contoured shape with internal stiffener board for maximum storage.
- » Durable TPU-coated ripstop nylon bar-tacked stress and rugged non-corrosive zippers.
- » Heavy-duty bilge pump/water bottle side storage panels.
- » Multi-function outer mesh compartments.
- » Multiple lashing options.

Kayak Waterproof Deck Bag **NEW**

- » Waterproof removable dry sack included (IPX6)
- » Large water-resistant main compartments
- » Contoured shape with internal stiffener board for maximum storage
- » Durable 420D polyester with bar-tacked stress points and rugged noncorrosive zippers
- » Heavy-duty bilge pump /waterbottle side storage panels (model #33517 only)
- » Multi-function outer mesh compartments
- » Multiple lashing options
- » 3/4" webbing with quick release buckles

All deck bags come with shoulder strap.



	AquaSurf 20
Product #	33505 (Yellow) 33506 (Blue)
Size	1220 in ³ (20 L)

	AquaWave 20	AquaTidal 25
Product #	33512 (Blue)	33517 (Blue)
Size	1220 in ³ (20 L)	1525 in ³ (25 L)



NIPISSING 40L **NEW**



Product # 33342 (Green) 33343 (Orange)

- » Waterproof Construction IPX6
- » Breathable Padded Foam Backing System
- » Adjustable Padded Waist Belt
- » Front Zippered Pocket
- » Mesh Front Pocket
- » Durable 500D Tarpaulin 1000D Bottom
- » Build-in Inflation & Compression Valve

Size: 14" x 27.5" x 8" (34 x 70 x 20 cm)

Volume: 40 L (2440 In3)

TEMAGAMI 40L **NEW**



Product # 33340 (Grey)

- » Waterproof construction IPX6
- » 300D Polyester TPU Coating
- » Padded Shoulder Straps
- » Front Zippered Pocket
- » All Seams RF Welded
- » Roll-over Quick Release Buckle Top Closure

Size: 14" x 28" x 7" (35 x 71 x 18 cm)

Volume: 40 L (2440 In3)

Paddler Dlx Dry Bag **NEW** 10, 20, 30, 40, 55

The Paddler series of waterproof dry bags are a necessity for all water sports activities. They feature a reinforced web roll-top and a very durable tri-laminated PVC body with an abrasion-resistant bottom. Quality dry bags that will keep your gear safe and dry.

- » 500D PVC Tarpaulin
- » 10L+20L+30L One Shoulder Strap
- » 40L+55L 2 Shoulder Straps
- » Web Roll-Top Closure
- » Heat Sealed Seams
- » IPX-6 Waterproofing



	10 L	20 L	30 L	40 L	55 L
Product #	33321 (Yellow) 33331 (Black)	33323 (Yellow) 33333 (Blue)	33325 (Yellow) 33335 (Lime)	33327 (Yellow) 33337 (Olive)	33329 (Yellow) 33339 (Orange)
Size	8" x 18" (20 x 47 cm)	9" x 23" (23 x 60 cm)	10" x 26" (27 x 67 cm)	12" x 28" (30 x 72 cm)	13" x 29" (33 x 74 cm)

AquaTight Duffel Bag (30L)

Product # 33302 (Gold)

Size: 1830 in³ (30 L)

This multi-purpose, Waterproof Duffel Bag is one of the most lightweight waterproof duffel bags available. The perfect solution for carrying all your gear to the beach, taking off on a rafting trip or just a weekend away.

- » Spacious waterproof main compartment
- » Dual Compression Strap systems for securing loads
- » Heavy-duty double-coated Ripstop nylon and hot-taped seams
- » Large web handles and shoulder strap for comfortable carrying
- » 2 outside pockets for small quick-access items





AquaLite Dry Bag



Multipurpose lightweight dry bags available in 5 convenient sizes and 3 colors. The perfect solution for keeping your gear dry and organized.

- » Flexible, curved U-shaped bottom makes for easy packing into kayaks, canoes and backpacks
- » Durable Ripstop nylon with waterproof coating and welded seam construction
- » Roll-down Velcro/flap closure system
- » Attached side D-rings and bar-tacked stress points for easy and safe lashing



	30 Liter	45 Liter
Product #	33222 (Grey/Yellow)	33225 (Blue) 33226 (Grey/Yellow) 33228 (Grey/Blue)
Capacity	1830 in ³ (30 L)	2745 in ³ (45 L)

Ultralite Compression Dry Sack



The backpacker's dream dry sack - it keeps your gear dry, clean, organized and compresses to a very compact size. These roll-top stuff sacks are made of ultra-lightweight and tough ripstop nylon fabric and have a convenient grab handle. All main seams are factory-seam-taped for complete waterproof protection.



	Small	Medium	Large	X-Large
Product #	33090 (Gold) 33091 (Black)	33093 (Gold) 33094 (Black)	33095 (Gold)	33097 (Gold) 33098 (Black)
Size	6.5" x 16.5" (17 x 42 cm)	8" x 18.5" (20 x 47 cm)	9" x 20" (22 x 51 cm)	10" x 20" (25 x 51 cm)
Weight	3.4 oz (96 g)	4.1 oz (116 g)	4.6 oz (130 g)	5.3 oz (150 g)
Capacity	600 in ³ (10 L)	915 in ³ (15 L)	1200 in ³ (20 L)	1600 in ³ (26 L)

AquaTight Dry Sack



These waterproof dry sacks are extremely lightweight and very compact - a great choice for backpackers, kayakers or anyone who requires lightweight gear that you can trust in extreme conditions. Made of durable ripstop nylon with a watertight roll-top closure and easy grab handle. All main seams are factory seam taped for complete waterproof protection.

	X-Small	Small	Medium
Product #	33070 (Gold) 33071 (Black)	33072 (Gold) 33073 (Black)	33074 (Gold) 33075 (Black)
Size	4" x 10" (10 x 25 cm)	5" x 13" (13 x 33 cm)	6" x 16" (15 x 40 cm)
Weight	1.5 oz (42 g)	1.8 oz (51 g)	2.2 oz (63 g)
Capacity	190 in ³ (3 L)	310 in ³ (5 L)	490 in ³ (8 L)



Our dry bags and electronic/document protectors are ideal ways to keep your gear dry, clean, and organized on any trip. Only the best ultra-lightweight and tough ripstop nylon fabrics have been used to provide worry-free waterproof protection for your valuables. Accessories are not included.



Special AquaTight features:

- » **Waterproof TPU-coated 70D Ripstop nylon and very tough TPU windows**
- » **All main seams are heavy duty RF-welded and watertight**
- » **Velcro or roll-over and double ziplock closures on all main openings of electronic, map and first aid protectors and pouches**
- » **Most items come with a lanyard and other lash points**

Waterproof Map Case



Product # 33010

Keep all maps and documents, organized, dry and clean in this ideal waterproof case. Constructed of abrasion-resistant, transparent vinyl with an easy seal top closure and adjustable lanyard. Ideal protection for all documents against the elements.

Size: 11" x 13" (28 x 33 cm)

Waterproof Wallet



Product # 33005

This very compact waterproof wallet is a great way to keep your ID, money and credit cards dry, clean and organized. Designed with 2 easy-to-access waterproof compartments, and made from abrasion-resistant, transparent vinyl.

AquaTight Camera/Passport Protector

Product # 33471 (Black)



AquaTight Waist Pouch

Product # 33426 (Black)



AquaTight First Aid Pouch

Product # 33435 (Red)



contents not included

WATERPROOF PROTECTION FOR YOUR VALUABLES

Waterproof IPX Ratings

The IPX standard gives you a clearer picture of how water resistant the item is, compared to vague marketing terms such as 'waterproof'.

The IP Code (or Ingress Protection Rating, sometimes also interpreted as International Protection Rating) consists of the letters IP followed by two digits or one digit and one letter and an optional letter.

The digits (characteristic numerals) indicate conformity with the conditions summarized in the tables below. Where there is no protection rating with regard to one of the criteria, the digit is replaced with the letter X.

IPX-7 rating is more than enough for outdoor sporting requirements.

IPX-0	No protection.
IPX-1	Protected against condensation or dripping water falling vertically.
IPX-2	Protected against spraying water when tilted up to 15 degrees vertically.
IPX-3	Protected against spraying water when tilted up to 60 degrees vertically.
IPX-4	Protected against splashing water from any angle.
IPX-5	Protected against low pressure water stream from any angle.
IPX-6	Protected against high pressure water stream from any angle.
IPX-7	Protected against water immersion. Immersion for 30 minutes at a depth up to 1 meter.
IPX-8	Protected against continual water submersion in under water conditions.



COOKWARE & TABLEWARE

Premium quality stainless steel cooksets made from very sturdy 18/8 polished stainless steel are perfect for any camping trip.

- » Lightweight and extremely durable
- » Cooksets nest into a compact package
- » Dishwasher safe
- » Include carry bags for clean storage and color box
- » Intended for use on gas stoves and heating elements

Plateau Stainless Steel Cookset

Product # 41030

Classic set for 2-3 person.

Contents:

- » 1.6 qt. (1500 mL) pot.
- » 2.1 qt. (2000 mL) pot.
- » 7.5" (19.5 cm) frying pan/lid combo fits both pots.
- » Pot gripper.



Plateau Stainless Steel Pot Gripper



Product # 41050

- » Essential camp kitchen item
- » Fits most pots and frying pans

Plateau Stainless Steel Expedition Cookset

Product # 41035

Great for longer outings and very hungry hikers!

Contents:

- » 1.3 qt. (1200 mL) pot.
- » 2.5 qt. (2400 mL) pot with folding handles and lid.
- » 6" (15 cm) frying pan and combo pot lid with fold-away handles.





Ridgeline Stainless Steel Solo Mess Kit



Product # 41011

Classic 5-piece individual set for hikers, campers & cyclists.

Contents:

- » 0.5 qt. (0.5 L) pot with lid
- » 7" (18 cm) frying pan with folding handle
- » 6.5" (16 cm) stainless steel plate
- » Plastic cup

Ridgeline Stainless Steel Single Cookset



Product # 41015

Perfect for 1 person.

Contents:

- » 0.75 qt. (712 mL) pot with lid
- » 1 qt. (950 mL) pot with lid
- » 5.5" (14 cm) frying pan with folding handles
- » Plastic cup

Ridgeline Stainless Steel Duo Cookset



Product # 41020

Perfect for 1-2 person.

Contents:

- » 1 qt. (950 mL) pot with lid
- » 1.5 qt. (1425 mL) pot with lid
- » 6" (15 cm) frying pan with folding handles
- » 2 plastic cups

Plateau Deep Plate



Product # 42010

Super durable, high quality 18/8 stainless steel plate is a versatile addition to your camp kitchen.

Diameter: 8" (20.5 cm)

Ridgeline Stainless Steel Camp Cookset

Product # 41040

Perfect for basecamp or large groups.

Contents:

- » 1 qt. (950 mL) pot with bail handle
- » 2.5 qt. (2375 mL) pot with bail handle
- » 6 qt. (5700 mL) pot with bail handle
- » 10" (25.4 cm) frying pan combo lid





This unique line of lightweight and extremely durable cookware features hard anodized aluminum construction, making camp cooking a breeze. Intended for use on gas stoves and heating elements

Ridge Hard Anodized Non-stick Cookset

- » Perfect for campers, mountaineers, backpackers and paddlers
- » Lightweight, extremely durable cookware with great heat conduction
- » Non-stick, easy-clean coating on the interior of the pots and frying pan
- » All components nest together into a compact package
- » Nylon stuff sack included



	Medium	Large	X-Large
Product #	41405	41410	41415
Contents	<ul style="list-style-type: none"> » 1 qt. (1000 mL) pot with folding handles » 1.7 qt. (1600 mL) pot with folding handles » 7" (18 cm) frying pan with folding handles 	<ul style="list-style-type: none"> » 1.7 qt. (1600 mL) pot with folding handles and lid » 2.7 qt. (2550 mL) pot with folding handles and lid » 7.75" (19.5 cm) frying pan with folding handles 	<ul style="list-style-type: none"> » 2.7 qt. (2550 mL) pot with folding handles and lid » 4 qt. (3800 mL) pot with folding handles and lid » 8.5" (21.5 cm) frying pan with folding handles

Aluminum 1 Person Cookset



Product # 41443

Cookset includes frying pan, pot and sierra cup. Folding handles for easy storage and transport. Special bottom increases heating efficiency.

Size: 6.9" x 2.75" (17.5 x 7 cm) - pot
6.5" x 1.45" (16.5 x 3.7 cm) - pan

Weight: 0.88 lbs (397 g)

Trekker Hard Anodized Cookset



Product # 41421

- » Perfect for campers, backpackers
- » Lightweight cookware with great heat conduction
- » All components nest together to save storage space
- » Designed for 4-5 person camping use

Contents:

- » 1 qt. (1000 mL) kettle/pot with lid and folding handles
- » 1.7 qt. (1650 mL) pot with folding handles and lid
- » 3.2 qt. (3056 mL) pot with folding handles and lid
- » 7.9" (20 cm) frying pan with folding handles
- » Nylon stuff sack included

Timberline Carbon Steel 12" Frying Pan



Product # 41487

Non-stick surface for easy cleanup and vinyl coated handle for comfort and grip. Folding handles makes it easy to pack and transport.

Size: 11.8" dia. x 1.9" (30 dia. x 4.8 cm)

Weight: 2.14 lbs (970 g)

Trekker Hard Anodized Frying Pan



Product # 41480 (7.75" / 19.5 cm) 41483 (8.5" / 21.5 cm)

- » Lightweight, extremely durable cookware with great heat conduction
- » Non-stick, easy-clean coating
- » Folding handles and carry sack for compact package





Timberline Stainless Steel Wine Goblet



Product # 42090

Reward yourself after a long hike with a glass of wine from this stylish, durable stainless steel goblet. Lightweight, rust-proof and easy to clean. Great for backpacking, boating and picnics. Cheers!

Size: 6 fl. oz (180 mL)

Timberline Nesting Stainless Steel Wine Goblet



Product # 42091

This nesting wine goblet makes it easy to pack for any trip, from mountain to cabin.
» Made of high quality food grade stainless steel
» Includes a stuff sack

Size: 9.0 fl. oz (265 mL)

Stainless Steel Hip Flask



Product #

41164 (8 fl. oz / 240 mL)

- » Rustproof, unbreakable and compact with hinged leak-proof cap
- » Made of durable, high quality 18/8 stainless steel

Timberline Double-Wall Mug



Product #

42112 (12.5 fl. oz / 350 mL)

42116 (14 fl. oz / 411 mL) *with lip

The Timberline Mug is a mountain classic with twin-wall thermal construction that will keep hot and cold liquids at the right temperature for hours. This mug is made of heavy duty stainless steel and will provide many years of service.

42116

Timberline Double-Wall Mug with Folding Handle



Product #

42120 (7.5 fl. oz / 220 mL)

42125 (10.5 fl. oz / 300 mL)

The perfect backpacking insulated mug with durable stainless steel, double-wall thermal construction that helps keep liquids hot or cold. Mugs stay comfortable to the touch. Handles fold for convenient packing and storage.

Timberline Single Wall Stainless Steel Mug



Product #

42102 (Clip Handle)

42103 (Folding Handle)

This lightweight, compact single wall mug is made of high quality stainless steel great for hikers and travelers.

Clip Handle

Folding Handle

Size: 10 fl. oz (300 mL)

Stove Windscreen **NEW**

Product # 18407

- » Foldable with plastic storage box
- » Ideal for single burner
- » 10 plate aluminum alloy
- » Hole for single burner hose
- » Built - in ground stakes

Size folded	Size unfolded	Weight w/case	Weight screen
9.5" x 3.25" x 0.6" (24 x 8.5 x 1.5 cm)	33" x 9.5" (84 x 24 cm)	8.5 oz (242 g)	11.5 oz (326 g)





Treeline Stainless Steel Cutlery Set



Product # 42050

Made of super-tough, rustproof stainless steel with a convenient detachable ring.

Ridgeline Stainless Steel Cutlery Set



Product # 42055

Perfect for all camping or backpacking trips. 3 piece knife, fork, spoon set. Made of high quality stainless steel.

Plateau Stainless Steel Cutlery Set



Product # 42060

Perfect for all camping or backpacking trips. Deluxe knife, fork, spoon set with ring. Made of high quality stainless steel.

Apex 2-piece Titanium Cutlery Set



Product # 42075

Spoon and fork set made of lightweight and extremely durable 100% Titanium. Connected with a convenient, detachable ring.

Apex Titanium Spork



Product # 42070

Made of lightweight and extremely durable 100% Titanium. Combination spoon and fork.

Plateau Stainless Steel Spork



Product # 42062

Made of high quality stainless steel. Combination spoon and fork. Built into the handle is a can opener.

Cooking Accessories

Plateau Folding Toaster



Product # 41060

Extremely compact toaster, perfect for any backcountry trip. Made of durable stainless steel and works on any camp stove. Just unfold, place a slice of bread on the grill and enjoy perfect toast.

Ridgeline S/S Folding Toaster **NEW**



Product # 41062

Compact and portable stainless steel, 2 slice capacity toaster for camping, boating, RV or home use. Silicone coated stainless steel swing out handles to ensure they remain cool to touch.

Expanded size: 9.8" x 5.5" x 3.9" (25 x 14 x 10 cm)
Folded: 9.8" x 5.5" x 1" (21 x 14 x 2.5 cm)

*Stove & fuel not included.



Camper 4 Person Tableware Set

Product # 42450

Ideal for any group camping trip. Made of durable plastic. Comes in plastic carry case.

Includes:

- » 4 knives, forks and spoons
- » 4 stackable 8 fl.oz mugs
- » 4 bowls (6")
- » 4 plates (7")
- » Salt and pepper shaker



Plateau Camp Kitchen 2 Person Set

Product # 42460

This Camp Kitchen Kit has everything 2 campers need to whip up a gourmet meal in the great outdoors.

Includes:

- » 2 sets of polycarbonate knife, fork, and spoon
- » Wire whisk and spatula
- » Can opener and salt and pepper shaker
- » 4 Squirt bottles and 2 small containers
- » Scrubber sponge
- » Organizer carry bag



Acadia Tableware 4 Colors

Acadia Tableware is made of all-purpose lightweight and durable polypropylene. An affordable choice for your next outdoor adventure, picnic, backpacking, day hike or boat-trip. Available in four colors.



	Mug	Bowl	Plate	Tableware Set*
Product #	42402 (Blue) 42404 (Green)	42410 (Blue) 42412 (Green)	42420 (Blue) 42422 (Green)	42425 (Blue) 42426 (Yellow)
Size/ Volume	14 oz (415 mL)	6" (15.5 cm)	9.5" (24.5 cm)	Cup 14 oz (415 mL) Plate 9.5" (24.5 cm) Bowl 6" (15.5 cm)



* Includes mesh dunk carry bag





Tea Kettles & Coffee Percolators

Ridge Stainless Steel Kettle

Product # 41005

Classic design provides the capacity of a 3 liter ultralight boiler in this easy-to-pour kettle design.

Volume: 0.8 gallon (3000 mL)
Weight: 1.1 lbs (530 g)



Plateau Stainless Steel Tea Kettle



Made from heavy gauge, 18/8 polished stainless steel and folding handles, these tea kettles make great tea at camp and at home. Designed to nest inside most Chinook cookware. Dishwasher-safe. Each kettle includes a quality storage sack with a drawcord closure.

It comes with an easy-to-clean stainless steel mesh basket for making herbal or leaf teas.

	Plateau
Product #	41107
Volume	29 fl. oz (850 mL)
Weight	12 oz (345 g)

Timberline Stainless Steel 3, 6, 9 & 12 Cup Coffee Percolator



The Timberline Coffee Percolator with its heavy gauge 18/8 polished stainless steel construction and heat insulating PermaWood handle makes perfect coffee at picnics, camp and home. This percolator has precision-fitting, seamless parts for brewing great coffee for years to come. Dishwasher-safe. Includes a quality storage sack with a drawcord closure.

	3 Cup	6 Cup	9 Cup	12 Cup
Product #	41210	41115	41120	41125
Volume	15 fl oz (444 mL)	30 fl oz (888 mL)	45 fl oz (1332 mL)	60 fl oz (1776 mL)
Weight	14 oz (390 g)	18.5 oz (525 g)	25 oz (716 g)	34 oz (375 g)
Insert	41112	41117	41122	41127
Knob	41111			

Canyon Aluminum Coffee Percolator



Product #
41320 (9 Cup) 41322 (Insert)
41330 (20 Cup) 41332 (Insert)
41321 (Knob)

Great for large camping groups, the Canyon Aluminum Coffee Percolator is made of durable, rustproof, polished aluminum. The Canyon has a percolator stem with basket and dual bail handles on top and the side for a steady pour. This percolator heats fast, pours and cleans very easily. Comes in a carry bag for clean storage.

Trekker Hard Anodized Tea Kettle



Product # 41315

High performance in a lightweight package. This extremely durable tea kettle offers great heat conduction and is perfect in camp and at home. Dishwasher-safe. Folding handle; designed to nest inside most Chinook cookware. Includes quality storage sack with drawcord closure.

Volume: 24 fl. oz (710 mL)
Weight: 7 oz (195 g)

Granite Espresso 6 Cup Coffee Maker



Product # 41356 (6 Cup)

This traditional steam-infusion espresso maker is still one of the most popular and easiest ways to brew a rich, delicious espresso in camp or at home. Lightweight and easy to clean. Made of durable aluminum.



BOTTLES & FLASKS

These stylish bottles are made of high-quality food-grade stainless steel. They are BPA-free and will not leach chemicals or other undesirable elements into your drinks. Very easy to clean using just soap and water, or simply pop them into your dishwasher.

Cascade Stainless Steel Bottle



	16 fl oz (500 mL)	32 fl oz (1000 mL)
Product #	41130 (Natural)	41135 (Natural)
Bulk (5pc)	41132 (Asstd Colors)	41137 (Asstd Colors)
Bulk (50pc)	41131 (Natural) 41133 (Asstd Colors)	41136 (Natural) 41138 (Asstd Colors)
Extra	41139 (Replacement Lid)	

ThermoMug Stainless Steel Vacuum Flask

Product #
41192 (17 fl oz / 500 mL)

The ThermoMug Vacuum Flask combines the outstanding thermal qualities of a double walled mug and a vacuum flask into one great package. The large double walled Mug has a spill proof lid that will help keep beverages hot longer. The spill proof lid can be stored in the flask bottom when not being used.





PERSONAL HYGIENE & CARE



Folding Washbasin



Product #
34924 (Yellow) 34921 (Blue)

Unique, lightweight, square washbasin with rigid stays holds up to 3.5 gallons of water. Folds up easily for convenient storage. Built of durable, tri-laminated PVC with welded seams and carrying handles.

Capacity: 3.5 gallons (13 L)
Size: 7" x 11" (17 x 28 cm) folded; 11" x 11" x 6" (28 x 28 x 17 cm) open

Folding Clear Water Bucket



Product # 34910

Carry up to 2 gallons of water in this heavy-duty bucket -- an ideal way to cut down on space and weight, making hauling water back to camp less of a chore. It's fast and easy to store and folds compactly. Made of durable PVC.

Capacity: 2 gallons (8 L)
Size: 9" x 1.5" (23 x 4 cm) folded; 9" x 11.5" (23 x 29 cm) open



Raindance Outdoor Shower

Product # 57050

Enjoy a hot shower on sunny days in camp with this solar-heated outdoor shower. Made of strong lightweight PVC and large enough for several showers, the Raindance is compact and easy to pack or store away. Features an easy-to-control water flow with an on/off hose.

Capacity: 5 gallons (20 L)





Microfiber Camp Towel

These deluxe camp and sport towels are made of super-soft and absorbent, ultra-fine microfiber fabric which allows water to be absorbed quickly and easily. Lightweight and ideal for camping, home use or traveling. 3 convenient sizes to choose from. Comes in a mesh bag for clean storage.



	Small	Medium	Large
Product #	51220	51225	51230
Size	10" x 20" (25 x 50 cm)	20" x 40" (50 x 100 cm)	30" x 50" (77 x 128 cm)

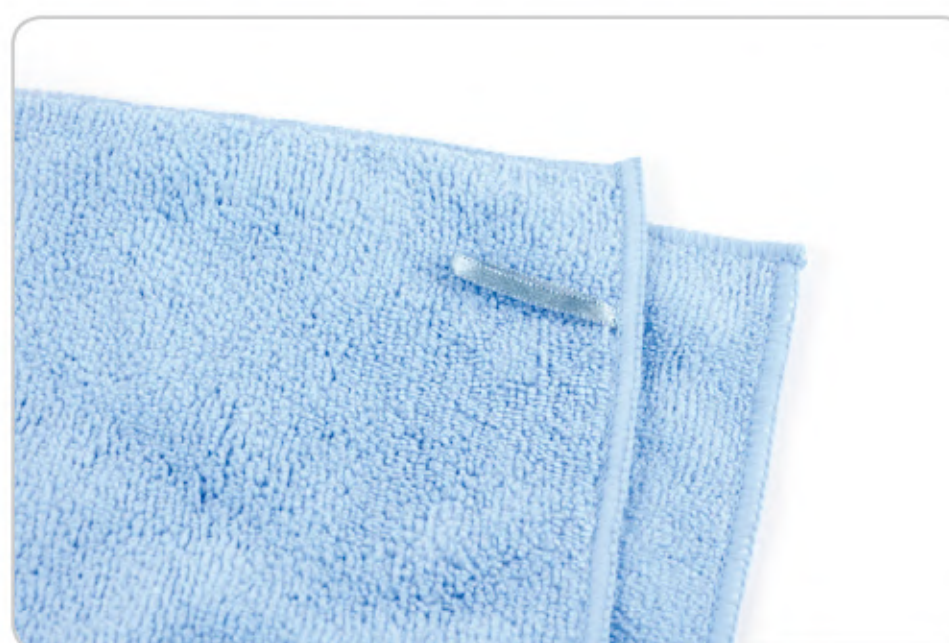

Camp Soap



Product #
 62201 (2 fl oz / 60 mL)
 62203 (4 fl oz / 120 mL)
 62205 (8 fl oz / 240 mL)

Camp Soap is biodegradable, concentrated and fragrance-free -- safe for cleaning hands, body, hair, clothing, dishes and more. This soap works in fresh or salt-water; hot or cold temperatures. (Made In USA)

Aloe Gator SPF 16 Moisturizing Lip Balm

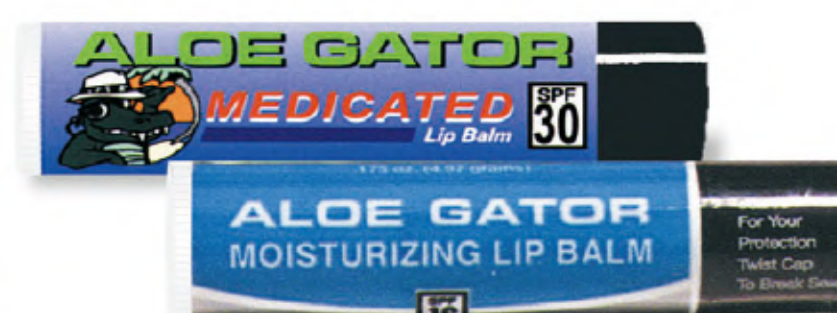

Product #
 62140 (0.175 oz / 4.9 g)

Aloe Gator lip balms protect while they moisturize and heal with the natural power of aloe. Regular use helps prevent and condition dry, chapped and sunburned lips. Anti-oxidant formulas glide on clear and comfortably.

Aloe Gator SPF 40 Total Sunblock Lotion

Product #
 62108 (3 fl oz / 90 mL)

Sunblock protection that lasts 8 hours. With aloe vera & a special formulation of ingredients, it moisturizes while protecting the skin. Waterproof & non-greasy.





EMERGENCY & FIRST AID

Esbit Stoves & Fuel



Esbit Pocket Stove

Product # 62240

- » 2-position cooking stove
- » Compact, lightweight and made of galvanized, hardened steel
- » Includes 6 individually packed water-resistant, perforated blister-packed solid fuel cubes



Esbit Emergency Stove

Product # 62241

- » Contains pliable flat stove made of hardened galvanized steel
- » Includes 3 large solid fuel cubes
- » Ideal for emergency situations



Esbit Solid Fuel Tablets 12 x 14G

Product # 62242

- » Individually packed in water-resistant, perforated blister packs.
- » Approximately 13 minutes burn time per cube
- » Can be extinguished and re-lit, reusable
- » One cube will bring 1 pint of water to a rolling boil in less than 8 minutes - strong heating output
- » Ignites with match or lighter

Esbit Solid Fuel Tablets 20 x 4G

Product # 62243





Aluminum Whistle



Product #
54014 (Small)
54016 (Large)

- » Lightweight, slimline pea-less whistle with attachment ring
- » Ideal for emergencies
- » Easily attaches to key-rings, zipper pulls and lanyards
- » Anodized aluminum
- » Bulk (25 pieces)

Marine Whistle



Product #
54017 Orange (Bulk 25 pieces)
54018 Black (Bulk 25 pieces)



- » ITW Nexus EN394 Marine Whistle
- » 2 chamber pea-less whistle
- » Super durable impact-resistant plastic
- » Ideal for emergencies -- very powerful sound pitch
- » Lanyard hole and large attachment clip

WhistleLoc Buckle



Product #
54020

- » Combination 3/4" quick-release buckle and pea-less safety whistle
- » Super durable impact-resistant plastic
- » Ideal for emergencies -- very powerful sound pitch
- » Bulk (25 pieces)

Thermal Emergency Sleeping Bag



Product #
57015

Another practical addition to every first aid/emergency kit, this durable, windproof, waterproof bag provides protection for all kinds of unexpected foul weather. The bag gives warmth by reflecting and retaining 90% of body heat. Very handy in an emergency situation to help prevent hypothermia and may be used inside or over a sleeping bag to give greater thermal warmth.

Size: 36" x 84" (91 x 213 cm)

Thermal Emergency Blanket



Product #
57010
57012 (Bulk 50 pieces)

Be prepared with this ultra light and compact emergency blanket. Made of silver aluminized polyester, it reflects a high percentage of the body's own heat and helps in the prevention and treatment of hypothermia. Waterproof, windproof, and flexible in freezing temperatures, this thermal blanket belongs in every hiker, boater and traveler's first aid/emergency kit.

Size: 48" x 81" (123 x 206 cm)

H/D Thermal Blanket NEW



Product #
57017

- » Aluminized Polyethylene Material
- » Reinforced Corner Grommets
- » Retains Body Heat By Reflecting Heat Back to Body
- » Stays Flexible in Cold Weather
- » Visible From The Air in All Season For Survival Rescue
- » Waterproof and Windproof

Size: 82" x 59" (210 x 150 cm)

Weight: 15.3 oz (435 g)

Mosquito Head Net



Product #
57060

- » Nylon top and fine mesh surround for protection against insects
- » Collar cinch area
- » One size fits all





HIKING & SNOW-SHOEING



Trekker Backcountry Snowshoes

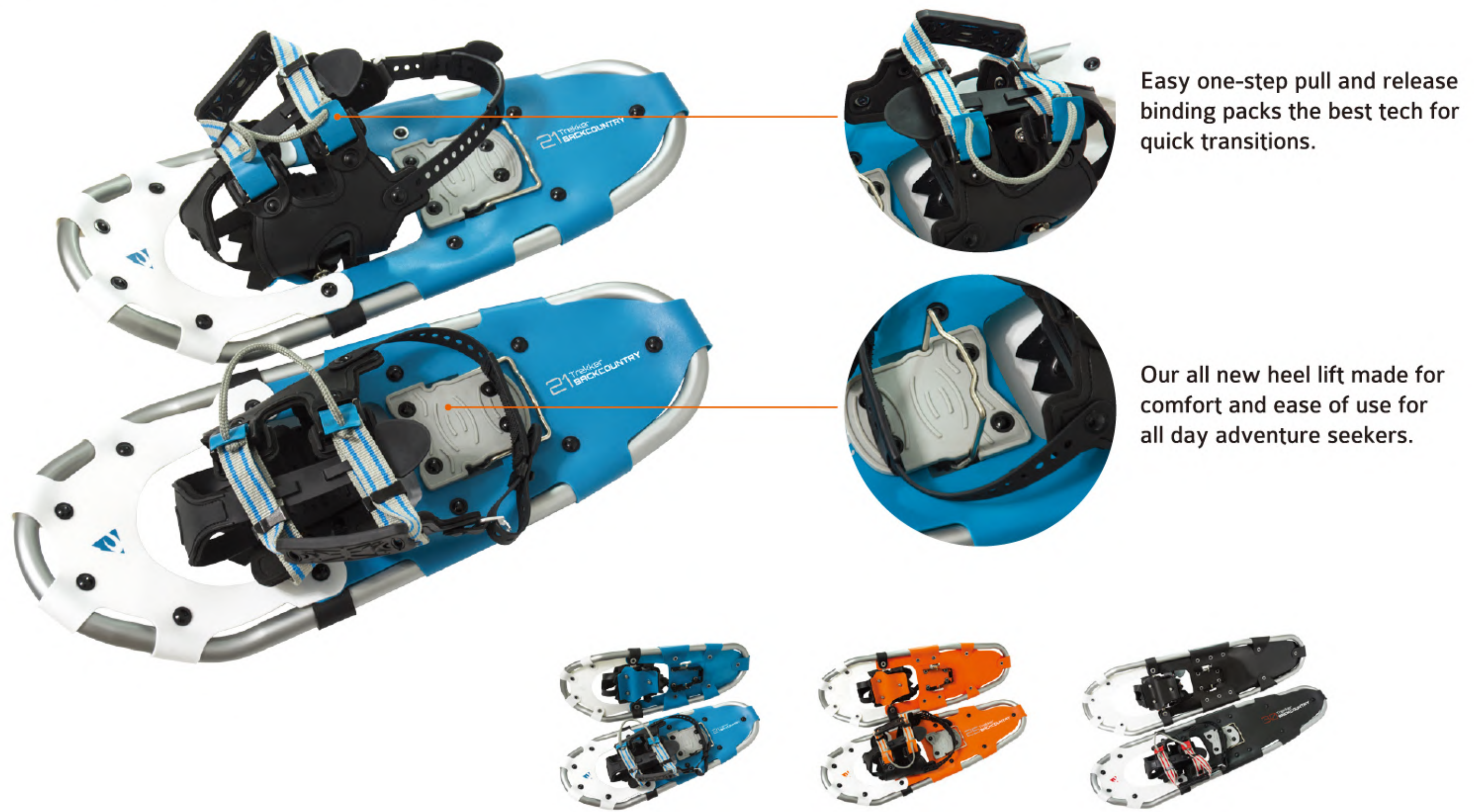

	Trekker Backcountry 21	Trekker Backcountry 25	Trekker Backcountry 30
Product #	80003	80005	80007
Recommended Load	90-130 lb (41-59 kg)	130-210 lb (59-95 kg)	180-250 lb (82-114 kg)
Aluminum 6061 frame	●	●	●
Polyethylene freeze-resistant deck	●	●	●
Aluminum 6061 crampon	●	●	●
Instep crampon	●	●	●
Heel crampon	●	●	●
Heel lift	●	●	●
Size	21"x8" (53x20 cm)	25"x8" (63x20 cm)	30"x9" (76x22.8 cm)
Weight	4.2 lb (1.9 kg)	4.4 lb (2.0 kg)	4.6 lb (2.1 kg)

Trekker Backcountry pictures are renderings and may differ slightly from the actual product.



Trekker Snowshoes

Trekker Series snowshoes provide great traction and comfort on packed snow and moderate terrains. Great for enjoying long winter months hiking through trails and forest.

- » Heel straps with quick release buckles that keep foot hold secure
- » UV resistant polyethylene decking and bindings are flexible up to - 40°F (- 40°C)
- » Light weight and strong aluminum frame features an ergonomic design to ensure comfortable and easy walks
- » Easy-to-use dual freeze-resistant ratchet bindings that are easy to adjust and give a secure fit even with gloves on
- » Heavy Duty Aluminum crampons, rotate freely to bite into snow and let the tails drop to shed snow ; heel crampons provide traction for heading down mild slopes
- » Includes carry bag



	Young Trekker 19	Trekker 22	Trekker 25	Trekker 30	Trekker 36
Product #	80020	80022	80024	80026	80028
Recommended Load	50-90 lb (23-41 kg)	90-130 lb (41-59 kg)	130-210 lb (59-95 kg)	180-250 lb (82-114 kg)	250-300 lb (114-136 kg)
Aluminum 6061 frame	●	●	●	●	●
Polyethylene freeze-resistant deck	●	●	●	●	●
Aluminum 6061 crampon	●	●	●	●	●
Instep crampon	●	●	●	●	●
Heel crampon	●	●	●	●	●
Size	18.9"x7.5" (48x19 cm)	22"x8" (56x20 cm)	25"x8.3" (63x21 cm)	30"x8.6" (76x22 cm)	36"x10" (91x25 cm)
Weight	3.91 lb (1.77 kg)	4.01 lb (1.82 kg)	4.3 lb (1.95 kg)	4.95 lb (2.25 kg)	5.43 lb (2.46 kg)

Snowshoes available as snowshoe + hiking pole combos, see below.



	Trekker Junior 14
Product #	80001
Recommended Load	up to 50 lb (23 kg)
Aluminum 6061 frame	●
Polyethylene freeze-resistant deck	●
Aluminum 6061 crampon	●
Instep crampon	●
Heel crampon	●
Size	14" x 17" (35 x 18 cm)
Weight	2.02 lb (0.92 kg)





Hiking Poles

Chinook Adjustable Hiking Poles will make you believe that two legs are good, three legs are better and four legs are the best on the trails. The outstanding craftsmanship of these strong and lightweight poles will make any hike easier for both novice and experienced hikers.



Product #	51011	51014*	51019	51024	51028	51035	51038	51040
Lightweight anodized aluminum pole	●	●	●	●	●	●	●	●
Three-section adjustable pole	●	●	●	●	●	●	●	●
Comfortable hand grip with web strap	●	●	●	●	●	●	●	●
Carbide tip for use on rocky or icy surfaces	●	●	●	●	●	●	●	●
One set of hiking baskets & snow baskets	●	●	●	●	●	●	●	●
Twist-lock height adjustment	●	●	●	●			●	●
Flip-lock height adjustment					●	●		
Chinook Antishock Spring system	●		●	●			●	●
Cork handle							●	
PU cork handle	●			●				
Extended EVA foam handle						●		
Camera-mount for use as monopod								●

All poles sold as single
*Available as snowshoe + hiking pole combo (details on next page)

Accessories



Small Basket
Product # 51042
(Bulk 25 pieces)



Large Snow Basket
Product # 51044
(Bulk 25 pieces)



Rubber Tip
Product # 51046
(Bulk 25 pieces)



Nordic Pole Tip
Product # 51048
(Bulk 25 pieces)



Small Basket
Product # 51043
(Bulk 25 pieces)



Large Snow Basket
Product # 51045
(Only fits #51035 pole)
(Bulk 25 pieces)



Tungsten Tip
Product # 51041
(Bulk 25 pieces)





STICKY SOLE AND POLE COMBOS

Folding Trekking Cane NEW

Product #	51012 (Blue)
Size	30"-34.5" (76 - 88 cm)
Collapsed	11.5" (29 cm) long
Weight	0.7 lb (335 g)
Material	6061 Aluminum



Folding Trekking Pole NEW

Product #	51032 (Blue)	51033 (Green)
Size	115-135 cm (Fits 5'8" & up)	105-120 cm (Fits up to 5'8")
Collapsed	16.5" (42 cm) long	15.3" (39 cm) long
Weight	0.62 lb (280 g)	0.58 lb (265 g)
Material	7075 Aluminum	





ATSKO SNO-SEAL®

Atsko Sno-Seal Beeswax Waterproofing



Product #
62301 (7 oz / 200g jar)
62303 (3.5 oz / 100g tube)

Original Beeswax Waterproofing protects leather from rain, sun, snow, and salt. The beeswax formula dries to a solid wax that “stays put” on the surface and in the pores of the leather so that it lasts longer.



- » Prevents water from penetrating leather
- » Lubricates and conditions leather without softening
- » Preserves and lengthens the life of leather
- » Does not interfere with the natural breathability of leather
- » Extremely resistant to salt stains and spotting
- » Does not soften heel counters or box toes
- » Maintains flexibility in freezing temperatures
- » Will not crack during continual flexing of leather
- » Will not damage seams or welts
- » Contains no silicone

Atsko Permanent Water-Guard



Product # 62319 (17 fl oz / 500mL Spray)

Permanent Water-Guard is solvent free, water-based fluorocarbon polymer water and stain repellent. It dries odor-free and without U-V brighteners. Guaranteed to remain effective even after 25 washings in Sport-Wash or Sensi-Clean. This is an extraordinary claim no other product is willing to make -- not even factory-applied Durable Water Repellents.

Atsko Water-Guard Extreme **NEW**



Product # 62321 (12 fl oz / 354mL Aerosol)

- » Allows leather + fabric to breathe
- » Scent free when dried + cured
- » Safe for use on gore-tex + all waterproof breathable fabrics
- » Contains U-V-BLOCK to protect colors and fabric from sun damage
- » Contains a fungicide to protect the invisible coating from odors and discoloration caused by mold, mildew, fungus and algae
- » For tents, footwear, outdoor clothing, tarps, boat covers, backpacks, golf bags, umbrellas, luggage, flags, + all 24/7 outdoor fabrics

Atsko Sport-Wash

Product # 62315 (18 fl oz / 532 mL)



Sport-Wash® is safe for all washable fabrics, and yet powerful enough to remove odors and your toughest stains such as soil, blood, and grass. Its secret is that unlike other detergents designed to leave brighteners, fragrances, and other residue behind, Sport-Wash rinses completely and cleanly, leaving nothing on your clothing (cotton, wool, insulations and synthetic materials) to clog the pores of your fabric.

- » Helps wickables wick and breathable-waterproof fabrics breathe
- » Restores loft and effectiveness to down and synthetic insulation
- » Rinses away completely leaving no residue
- » Cleans and deodorizes; leaves no scent
- » Safe for all washables; for machine or hand washing
- » Biodegradable and completely septic safe
- » Helps frequently washed garments last longer
- » Helps restore factory applied waterproofing

Atsko Silicone Water-Guard



Product #

62317 (10.5 fl oz / 300g Aerosol)
62311 (4 fl oz / 118mL With Dauber)

Silicone Water-Guard® is suitable for outerwear, footwear, tents, sleeping bags, and suede. Our silicone is specially formulated to apply maximum repellency in a single application. It restores factory waterproofing but still allows materials to breathe. It repels water and stains. Dries in 24 hours and will be odorless and fully cured in 72 hours.



- » Restores and replaces factory waterproofing
- » Works on silicone-impregnated leather
- » Also works on suede, brushed leather, and textiles
- » Allows materials to breathe
- » Contains no chlorinated solvents or propellants in the aerosol (uses environmentally-safe CO₂ instead)



CTO™ FOOTWEAR

Approach Short Gaiters **NEW**



Product

32505 (S/M 5 to 8)
32510 (L/XL 9 to 13)

Lightweight and durable ankle-high gaiters - for approach /day hiking, trail runners, x-country and leather boots.

- » Height: 9.5" (24 cm) for S/M & 10.5" (26.7 cm) for L/XL
- » Weight: approx. 105 g (3.7 oz)
- » Waterproof Breathable Material
- » 600D Ripstop Polyester
- » Trail Running, X-country skiing, Hiking, Snowshoeing, Golf
- » Tick & Mosquito Proof Gaiters
- » Carry Bag Included

CTO™ Heavy Duty Backcountry Gaiters



Product

32535 (Small 5 to 7)
32538 (Medium 7 to 9)
32540 (Large 9 to 11)
32543 (X-Large 11 to 13)

Heavy duty, high-top gaiters - for backcountry ski boots, leather hiking boots and plastic mountaineering boots.

- » Super Tough, 1000D HDTEX polyester with lined cuff.
- » Very durable, waterproof PU coating on all fabric.
- » Heavy-duty, instep strap with metal buckle.
- » Ergonomic design and 2" wide Velcro closure at front allows for easy custom fitting.
- » Web strap adjustment at top with quick-release buckle.
- » Easy grab tabs and front bootlace hook.

CTO™ Rambler Gaiters



Product

32515 (Small 5 to 7)
32518 (Medium 7 to 9)
32520 (Large 9 to 11)
32523 (X-Large 11 to 13)

Lightweight and durable, high-top gaiters - for approach/day hiking, x-country, leather and most plastic mountaineering boots.

- » 420D HDTEX ripstop polyester uppers, 1000D HDTEX polyester bottoms.
- » Very durable, waterproof PU coating on all fabric.
- » Heavy-duty, instep strap with nylon buckle.
- » 2" wide Velcro closure at front allows for easy custom fitting.
- » Ergonomic design and shockcord tops with cord-locks for a snug seal.
- » Easy-grab tabs and front bootlace hook.

CTO™ Waterproof Breathable Backcountry Gaiters



Product

32555 (Small 5 to 7)
32558 (Medium 7 to 9)
32560 (Large 9 to 11)
32563 (X-Large 11 to 13)

Waterproof/Breathable, high-top gaiters - for back country ski boots, leather hiking boots and plastic mountaineering boots.

- » 3 Layer eVENT® ripstop nylon uppers, 1000D HDTEX polyester with lined cuff
- » Waterproof/Breathable uppers and waterproof PU coating on lower cuff
- » Heavy-duty, instep strap with metal buckle
- » Ergonomic design and 2" wide Velcro closure at front allows for easy custom fitting
- » Web strap adjustment at top with quick-release buckle
- » Easy grab tabs and front bootlace hook



Limited Warranty

Chinook Technical Outdoor offers a limited warranty on every product to be free of manufacturer defects.

If you have a warranty issue, consult with the dealer first. The dealer will initiate the warranty repair procedure with us. We will repair it if possible or replace all valid warranty items. The Law states that products accepted for review must be clean; it is prohibited to request our repair partners to work on dirty items. Please clean your Chinook product before returning it to us or cleaning charges must be assessed before a review can be made. Normal wear and tear modifications, alterations, negligence, damage and use for a purpose other than for which was designed, are not covered by the Chinook warranty. A charge will be quoted for non-warranty repairs. The Chinook® Limited Warranty does not apply to products that are used for rental purposes.

USA

GREENLAND SALES CORP.
Box 11, 2221 Niagara Falls Blvd.
Niagara Falls, New York
USA 14304
Tel: 1.800.513.8299
Fax: 1.800.273.8451

WEB

www.chinooktec.com
info@chinooktec.com



Limited 1-Year Warranty

Trailside offers a limited 1-year warranty on every product to be free of manufacturer defects.

If you have a warranty issue, consult with the dealer first. The dealer will initiate the warranty repair procedure with us. We will repair it if possible or replace all valid warranty items. The Law states that products accepted for review must be clean; it is prohibited to request our repair partners to work on dirty items. Please clean your Trailside product before returning it to us or cleaning charges must be assessed before a review can be made. Normal wear and tear modifications, alterations, negligence, damage and use for a purpose other than for which was designed, are not covered by the Trailside warranty. A charge will be quoted for non-warranty repairs. The Trailside® Limited 1-Year Warranty does not apply to products that are used for rental purposes.

CANADA

GREENLAND SALES LTD.
3145 14th Avenue
Markham, Ontario
Canada L3R 0H1
Tel: 1.905.513.0333
Fax: 1.905.513.9809

